



ELTMR

Elite Edge-Lit Master Exit Sign, Remote Exit Sign Capable

DATE:

PROJECT

COMMENTS:



FEATURES

- Illumination 4 times brighter than UL 924 requirement with super-bright, long-life LEDs that have a 25+ year life expectancy
- Master Exit Sign compatible with LPDCREM & TLREM2 Remote Exit Signs
- Premium long-life, high-temperature fused nickel cadmium battery with standard UL listed 3-hour run time
- Battery diagnostic system standard – battery status: detects cell failure and issues alert of reduced capacity and the need to replace battery
- Line-latch prevents unnecessary discharge of battery during installation. Loads will not illuminate until after application of utility power
- Specialty finish upon request
- Brownout detection ensures emergency operation during periods of low line voltage
- Sealed external momentary test switch and dual diagnostic LED indicator displays AC presence and Hi-Charge status
- Self-Test / Self-Diagnostic monitoring available
- Zero current low-voltage disconnect
- Slimline, low profile surface mount housing eliminates need for recessed box in wall mount applications
- Unique electronic driver circuit provides current control and protection, ensuring optimum LED efficiency and life
- 120/277 VAC field-selectable inputs (with the exception of the dual-circuit option which requires voltage specification upon ordering)

CEC Title 20



ORDERING INFORMATION *ELTMR-AC-G-1C-AG-BA-MB-AB*

1. SERIES	2. OPERATION	3. FACE COLOR	4. FACE COUNT	5. FRAME STYLE	6. FRAME COLOR
ELTMR	-	-	-	-	-
	AC AC Only EM Ni-Cad Battery Backup	G Green G8 Green 8 letter R Red R8 Red 8 letter	1C Single Face, Clear Background 1M Single Face, Mirror Background 1W Single Face, White Background 2M Double Face, Mirror Background 2W Double Face, White Background	AG Angular FT Flat Trim ¹	BA Brushed Aluminum BK Black BR Brass CC Custom Color WH White

7. MOUNTING

MRCLB	Recessed Ceiling Mount, Preship Backbox
MB	Back Mount
ME	End Mount / Side Mount
MRC	Recessed Ceiling Mount

MT	Top Mount
MMB	Mullion Mount (Bottom)
MMR	Mullion Mount (Rear)
MMT	Mullion Mount (Top)

MPA	12" Pendant Mount
MPB	24" Pendant Mount
MPC	36" Pendant Mount
MPD	48" Pendant Mount

8. CHEVRON

AB	Double Arrow
AL	Arrow Left
AN	No Arrows
AR	Arrow Right
AS	Right & Left Arrow
AU	Universal Chevron Kit

9. OPTIONS

BLANK = NO OPTION

C1	Dual Circuit (120 VAC) (AC Only)
C2	Dual Circuit (277 VAC) (AC Only)
SD	Self-Diagnostics (EM Only)
SR	Self-Diagnostics + IR Remote Testing Receiver (EM Only)

PE	Euro Panel
PV	Inverted Panel (Legend)
VF	Other Input Voltage (Indicate Volt & Frequency)
FL	Flasher
FLA	Flasher / Audible Alarm

CW	Custom Wording
FA	Fire Alarm Interface
FAA	FA Option w/Audible Alarm
LD	Damp Location

ORDERING NOTES

1. Flat Trim only compatible with recessed mounting
2. For remote exit signs, see TLREM2 and LPDCREM
3. This product is not compatible with remote lamp heads.

ACCESSORIES ON BACK

ACCESSORIES; ORDER SEPARATELY

- ELT-ACCY-RBB = Recessed Backbox for ELT
- TLRT = Handheld Remote Control Test Unit, used with SR option
- WG 1 = Wire guard 17.0" X 17.0" X 17.0"
- WG 10 = Wire guard 13.5" X 12.0" X 16.5"

CONSTRUCTION

- "Snap-in Lens" for easy installation.
- Recessed back box can be pre-installed at job site
- Precision die-cast aluminum housing with a flawless, laser-formed acrylic legend
- Hinged springs allow for concealed mounting hardware on recessed models
- Back box can be pre-installed
- Recessed back box meets New York specifications
- Compatible with the LPDCREM and TLREM2 remote exit signs

INPUT POWER

- AC models: Red 1.5 watts; Green 2.3 watts
- EM w/Remote Exit Sign: Red 3.0 watts; Green 4.0 watts

LETTERS

- 6" high; 0.75" stroke

ARROWS

- NFPA-Type, universal field installable, self-adhesive chevrons

APPROVALS

- UL 924
- CEC Title 20 Compliant
- NFPA 101 Life Safety Code
- NFPA 70- NEC
- OSHA
- Recessed backbox is IC rated and meets New York specifications.

TEMPERATURE RATING

- From 32°F to 102°F

WARRANTY

- Isolite offers a 5-year limited warranty. For further details, refer to General Warranty and Obligations in the Isolite manual or on our website

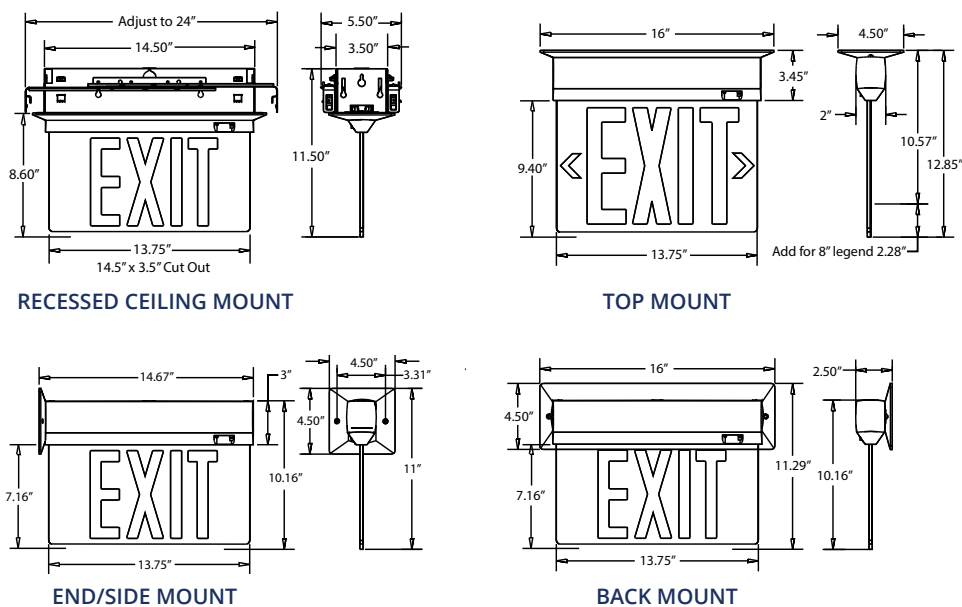
DIMENSIONS

CHEVRON DECODER

1) MOUNTING CONFIGURATION

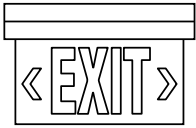
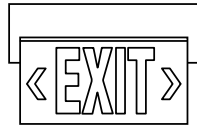
 Ceiling Mount
 (Recessed or Surface)

 Wall Mount
 (Surface Only)

 End Mount Right
 (Surface Only)

 End Mount Left
 (Surface Only)

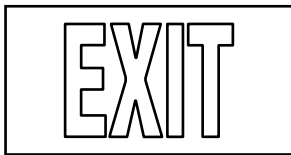
2) CHEVRON DIRECTION



No Chevron (NA)

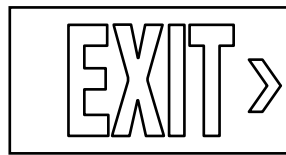

Right Chevron (AR)

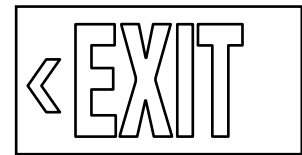

Left Chevron (AL)

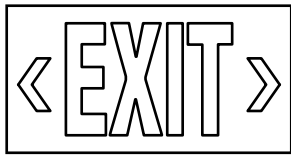

Double Chevron (AB)

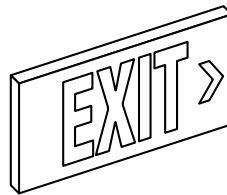

SIDE A



SIDE B

 Left & Right Chevron (AS)
 (Double Face Only)

PANEL FIELD REPLACEMENT

In some instances, the ELT panels can be replaced in the field. The single face clear panel replacements must be performed in an Isolite manufacturing facility. For more information please call Isolite customer service.

		DESIRED CHANGE				
		1C	1M	1W	2M	2W
EXISTING SIGN	1C		No	No	No	No
	1M	No		Yes	Yes	Yes
	1W	No	Yes		Yes	Yes
	2M	No	Yes	Yes		Yes
	2W	No	Yes	Yes	Yes	