

## Installation / Operation Manual Emergency Lighting Central Inverter System

1KW -17KW  
SINGLE PHASE  
MODELS

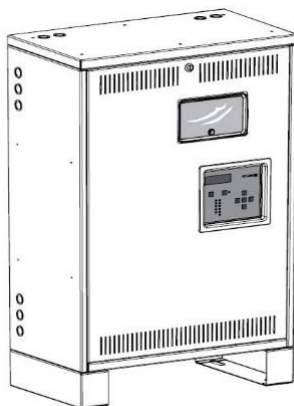

1KW MODEL  
SHOWN

### IMPORTANT SAFEGUARDS

When using electrical equipment, basic safety precautions should always be followed including the following:

### READ AND FOLLOW ALL SAFETY INSTRUCTIONS

- A. Do not use outdoors
- B. Do not mount near gas or electric heaters.
- C. Use caution when servicing batteries. Battery acid can cause burns to skin and eyes. If acid is spilled on skin or in eyes, flush acid with fresh water and contact a physician immediately.
- D. Equipment should be mounted in locations and at heights where it will not readily be subjected to tampering by unauthorized personnel.
- E. The use of accessory equipment not recommended by the manufacturer may cause an unsafe condition.
- F. Do not use this equipment for other than intended use.

This unit contains lethal voltages. There are no user serviceable parts inside. Only authorized service personnel are to be used for service.

### SAVE THESE INSTRUCTIONS

The installation and use of this product must comply with all national, state, municipal or local codes that apply. Please read this manual thoroughly before installing and operating the E3-MAC Series central inverter system. For assistance please call ISOLITE technical support at 800-967-5573 and speak to a technician during normal business hours (EST).

# TABLE OF CONTENTS

## **1.0 Introduction**

- 1.1 Mechanical Design Features
- 1.2 Electrical Design Features

## **2.0 Receiving and Storage**

- 2.1 Inspection
- 2.2 Storage

## **3.0 Installation**

- 3.1 Location
- 3.2 Operating Environment
- 3.3 Ventilation
- 3.4 Clearance
- 3.5 Floor Preparation
- 3.6 Cabinet Configurations

## **4.0 AC Connections**

- 4.1 Removing the AC Breaker cover
- 4.2 Installing the Input Wires
- 4.3 Installing the Output Wires
- 4.4 Special Options

## **5.0 Battery and DC Connections**

- 5.1 Battery Inspection
- 5.2 Battery Installation
- 5.3 DC Voltage of System
- 5.4 Battery Wiring Diagram(s)

## **6.0 Startup and Shutdown Procedures**

- 6.1 Startup Procedure
- 6.2 Shutdown Procedure

## **7.0 System Operation**

- 7.1 Startup Mode
- 7.2 Battery Charging Mode
- 7.3 Inverter (Battery Discharge) Mode
- 7.4 Normally-On Output
- 7.5 Normally-Off / Switched Output

## **8.0 Specifications**

## **9.0 Warranty**

- 9.1 Technical Service and Support
- 9.2 Return Material Authorization (RMA)

## **10.0 Man Machine Interface (MMI)**

- 10.1 Introduction
- 10.2 System Test Button
- 10.3 Alarm Silence Button
- 10.4 Keypad and Display Features
- 10.5 SD Card
- 10.6 USB Slot
- 10.7 Main Menu
- 10.8 Meter Menu
- 10.9 Alarm Menu
- 10.10 Event Log
- 10.11 Test Log
- 10.12 Alarm Log
- 10.13 User Menu  
User Menu Navigation

## **11.0 Maintenance and Service**

- 11.1 Battery Maintenance
- 11.2 Battery Replacement

## **12.0 Web Interface**

# 1.0 INTRODUCTION

The E3-MAC Central Inverter System integrates the latest power electronics and microprocessor technology and produces a pure sine wave power output intended for use in Emergency Lighting. The system is very efficient on-line and typically has a standby power loss of only 2 percent of the systems total capacity. This high efficiency and the ability to turn lighting loads on and off using the optional switched load outputs make it ideal for energy saving and green initiatives. It is UL-924 compliant for Self-Testing and Self Diagnostic which automatically performs internal tests and then records them in its backup logs. The MMI (Man Machine Interface) consists of a 5-button keypad and backlit LCD display which is very powerful and feature rich. Users can access all stored logs and diagnostic tools such as meter functions, they can also change alarm functions and much more.

## 1.1 Mechanical Design Features

This product was designed having the electrical installer in mind. Batteries are Front Access type which simply slide into the cabinet and connect with Busbar jumpers. They are easy to install, safe and less prone to installation errors. The AC connections are also easily made with the contractor landing the inputs and outputs to either Circuit Breakers, terminals of busbars. Contractor piping for conduit is easily accomplished with multi-sized knockouts on both sides and tops of the cabinet so wires can easily run into the cabinet and connected to ground bars, neutral bars and circuit breakers.

The machine has an attractive Powder Painted 14 gauge Cold Rolled Steel construction with no visible outside bolts or rivets. Internally, it has all galvanized or painted steel parts for all the modules and shelves that resist corrosion and provide durability and high quality.

## 1.2 Electrical Design Features

Through the use of Pulse Width Modulation (PWM) and the latest IGBT and MOSFET technology, the E3-MAC Series can produce a pure sine-wave output which is compatible with all types of lighting loads. A high crest factor of up to 4X is extremely beneficial for high-inrush loads and also ideal for bringing Normally-Off lighting loads on from a cold start. Since the active PWM regulation scheme produces a very low THD waveform, the E3-MAC Series can power up even the most demanding loads driving its output with power factor capabilities ranging from 0.5 leading to 0.5 lagging.

Adding to the versatility are the multiple output types of Normally-On, Normally-Off and Switched. The batteries are charged by a temperature compensated charger integrated into a bi-directional converter. A three-rate charging scheme and bi-directional converter topology ensures maximum float life and minimal ripple current on the batteries.

## 2.0 RECEIVING AND STORAGE

### 2.1 Inspection

The E3-MAC Series central inverter and batteries are shipped together unless specified with the “ship-less batteries” option code(-UP). Upon arrival, please inspect the contents to ensure that no shipping damage has occurred. This is especially important with batteries – ensure that there are no cracks or leaks. If any damage has occurred, notify the shipping carrier immediately and submit a damage claim.

**WARNING** - **NEVER** use a physically damaged battery as this may cause an unsafe condition.

### 2.2 Storage

Storage temperature before the installation is critical for the battery life expectancy and warranty. Store the system indoors in a clean, dry and cool location. Storage at higher temperatures will result in accelerated rates of self-discharge and possible deterioration of battery performance and life.

**WARNING** – **The maximum storage time from shipment to initial charge is 6 months** for batteries stored at ambient temperatures no warmer than 77°F (25°C). For storage temperatures greater than 77°F (25°C) the batteries must be recharged one (1) month sooner for every 5°F (3°C) increase above 77°F (25°C).

Storage times exceeding the above may result in plate sulfation, which may adversely affect electrical performance and expected life.

***Failure to install and charge the batteries as noted  
VOIDS the battery’s warranty***

**DANGER** - Batteries present a risk of electrical shock and high short circuit current. Do not smoke, cause a flame or spark in the immediate area of the batteries. Use proper lifting means when moving batteries and wear all appropriate safety clothing and equipment.

## 3.0 INSTALLATION

### 3.1 Location

NEC article 700 EMERGENCY CIRCUITS should be referenced for proper installation of a central inverter system. Article 700 dictates that unit must be mounted in a permanent location. Choose a cool dry place with normal ventilation and one which will allow easy access for testing and maintenance. Avoid a location which could allow vandalism and tampering. Avoid areas that would prohibit visual contact with the heads-up LED status displays.

### 3.2 Operating Environment

Choose a location that is controlled between 20 and 30 °C for optimum battery life. E3-MAC Series is UL924 listed between 20 and 30 °C due to the battery discharge performance results. Colder temperatures decrease the batteries discharge duration (90 Minutes is required per UL924 and NEC Article 700) and warmer temperatures will adversely affect battery life. The optimal temperature of the E3-MAC Series system will be 25°C / 77°F and all measures should be made to keep the batteries in this temperature zone. Temperature -vs- Life expectancy is shown below.

#### Effect of Temperature on Long Term Float Life

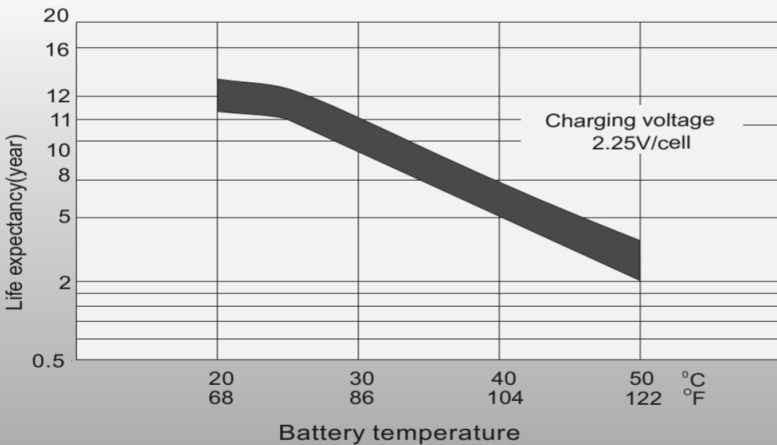

### 3.3 Ventilation

Because the E3-MAC Series uses a maintenance-free sealed valve regulated lead acid (VRLA) battery, no special ventilation is required. Spaces normally occupied by humans with either natural or forced ventilation allowing at least 1 to 2 air exchanges per hour is recommended. Choose a mounting location that is clean and dust free. Do not install in areas where there is particulate or high pollution degree from heavy industrial machinery, corrosive chemicals or welding or plasma cutting environments etc.

### 3.4 Clearance

Air ventilation is through the front surface so there are no clearance requirements for the top, back or sides of the cabinet. However, the NEC code does require an unobstructed 3 ft. of clearance in front of the cabinet (i.e. electrical panels).

### 3.5 Floor Preparation

The mounting floor should be smooth and level so that the cabinet is not skewed or twisted which would prevent the systems front door from being easily removed. Final system leveling should be accomplished by shimming the cabinets corners so that the front door can easily be removed for service. Floor mounting holes are provided in the cabinet's base and will accommodate up to a 3/8" mounting bolt. All 4 mounting holes should be secured with bolts due to the weights of the cabinet(s) and associated batteries. We recommend concrete wedge anchors such as the Hilti brand Wedge Anchor series Kwik Bolt TZ or equivalent.

### 3.6 Cabinet Configurations

There are 4 cabinet sizes/configurations for the E3-MAC Series. Electrical Knock Outs (EKO's) are provided on three surfaces. Ensure all metal conduit is secured and tightened creating a good connection to earth ground. Use an Ohm-Meter to check that continuity between conduit and protective earth ground has been established.

Seismic bracing is available for the E3-MAC Series. Please see [Isolite.com](http://Isolite.com) for details of seismic dimensions and configurations.

**Note** – Cabinet sizes and construction may change due to optional features such as mixed voltages which require Isolation Transformers and/or Auto-Transformers.

All systems are shipped with a Contractors Guide for each model. This should be referred to in the installation process since there may be more details available.

**WARNING** – Drilling into cabinet may void warranty if metal filings causes unit failure.

### 3.6 Cabinet Configurations (cont.)

- Size 1** 1KW
- Size 2** 1.6KW, 2.2KW, 2.8KW, 3.0KW
- Size 3** 4.0KW, 5.0KW, 6.0KW
- Size 4** 8.0KW, 10.0KW, 12.5KW
- Size 5** 13.3KW, 17.0KW

**Note** – Standard cabinet configurations for all sizes are shown. Other cabinet configurations may be used when optional features are provided such as mixed Input/Output voltages which requires isolation or auto-type transformers. These options require additional cabinet space which may increase size.

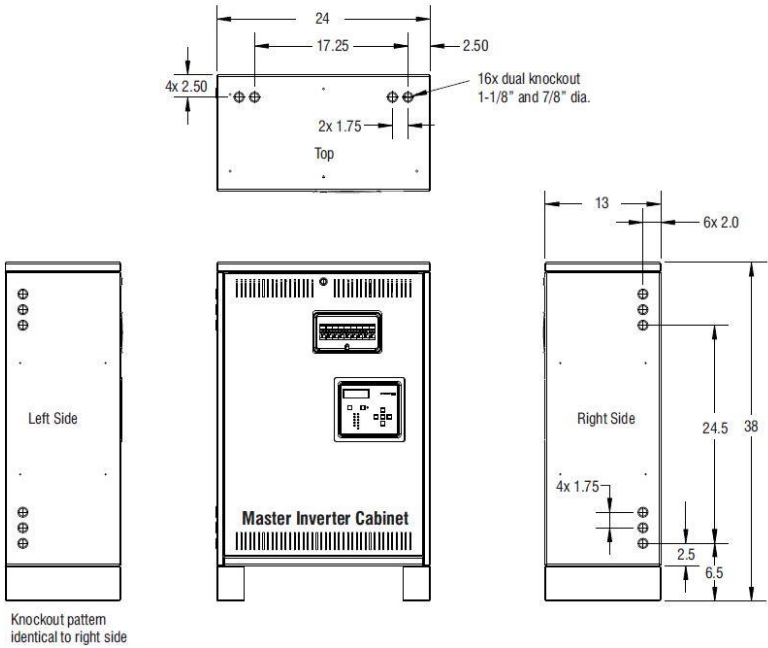

## SIZE 1 1KW Model

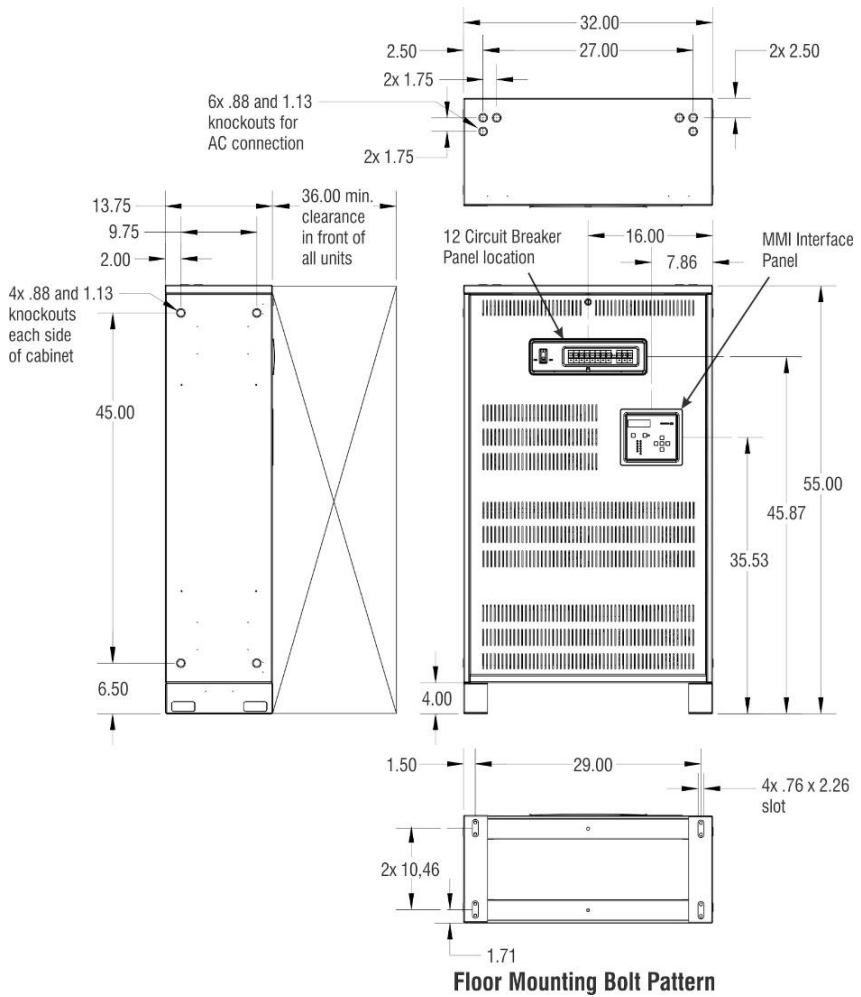

## SIZE 2

**1.6KW thru 3.0KW Models**



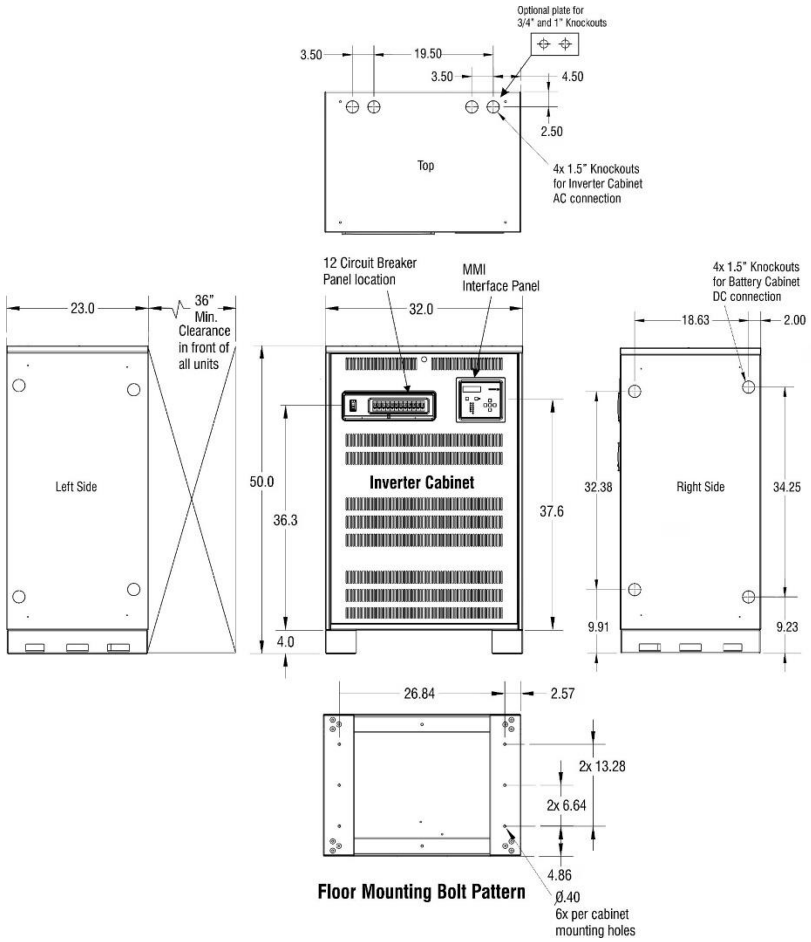

## SIZE 3

### *4.0KW thru 6.0KW Models*

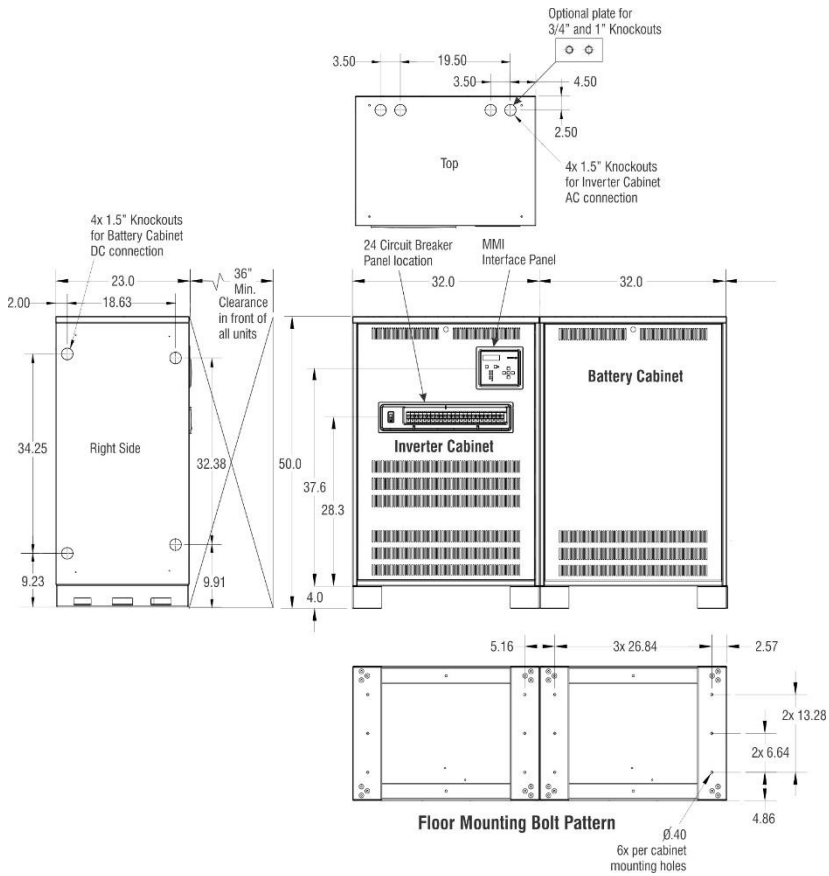

## SIZE 4

*8.0 KW thru 12.5 KW Models*

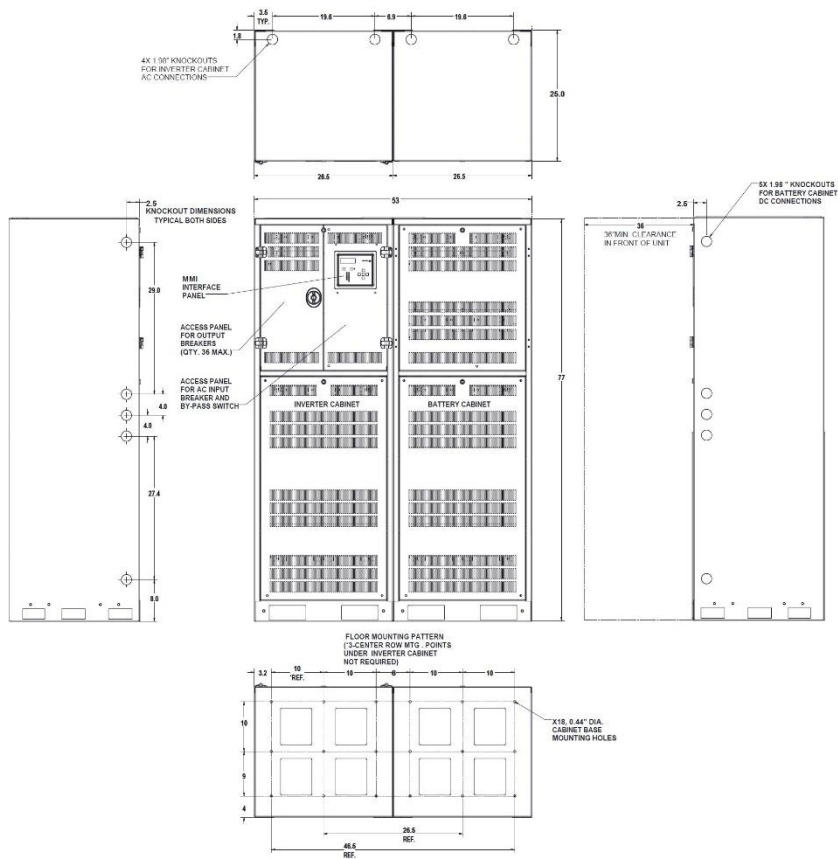

## SIZE 5

**13.3 KW thru 17 KW Models**

## 4.0 AC CONNECTIONS

**WARNING** – Only qualified personnel that are familiar with AC and DC installation techniques and codes (such as an electrician) should perform the Installation.

**WARNING** – The E3-MAC Series contains lethal AC Voltages. Due to the hazard of high voltage electrocution, always shut down all sources of power before you install, maintain, or service the unit.

**WARNING** – Remove all rings, watches, and other jewelry before doing any electrical service or installation work. Always wear protective clothing and personal protective equipment (PPE) that is suitable such as eye protection when working near batteries.

**NOTE** - Always check the system's rating label located on the cabinets left side interior wall and also the system's door.

**Use copper wire only – read all warning labels provided in the cabinet!**

### 4.1 Removing the AC Breaker cover

To access wiring to the breakers, remove the two ¼-20 bolts from the plastic breaker cover with a 3/8 socket or nut driver.

**Note** - This cover conceals the wiring area and also provides a safety barrier so fingers do not inadvertently touch live parts after installation. Always re-install the AC Breaker cover to prevent accidental contact with live wires during routine maintenance.

### 4.2 Installing the Input Wires

1. Ensure that the System ON/OFF switch is in the OFF position before starting.
2. Ensure that the incoming feed AC voltage matches the voltage rating of the model you have. Please refer to the systems rating plate label.
3. Ensure that the feed breaker from the panel has enough ampacity to allow for the full rating of the input current required on the systems rating plate.

Once the Utilities AC input feed voltage and Feed breaker size is confirmed, connect the utilities feed AC wires to the systems Input circuit breaker (UL489 rated for direct connection), Terminal Block NEU (Neutral) and grounding terminal block (GND). Ensure wire connections are secure to all connection points by briefly tugging the wires to ensure a solid, secure connection with low continuity.

**NOTE** – AC Input wiring may have to be landed to a Terminal Block instead of the Input Breaker if a Bypass Switch or Mixed Voltages are present on your system.

## 4.3 Installing the Output Wires

Connect the load wires to the Normally-On output terminal blocks. If your system has output breakers, connection directly to these circuit breakers are permitted since these are also UL489 rated. Other output configurations could include Normally-Off or Switched outputs which also use circuit breakers as the connection points. Please refer to your systems part number for your specific output configurations. Ensure that the connections to these terminal blocks or breakers are secured by briefly tugging the wires. See Section 7.4 thru 7.5 for further load type details.

**NOTE** – AC Input and AC output wires must be run in separate conduit or raceways per NEC ARTICLE 700. Please ensure all codes and standards are observed.

**NOTE** – E3-MAC Series requires that the Neutral and Ground potential does not exceed 5 VAC for proper function. Anything above 5 VAC typically indicates that there may be an issue such as grounding, inadequate conductor size or continuity. This should be looked at immediately as it could cause a safety concern.

**NOTE** – Neutral and ground should never be tied together anywhere in the E3-MAC Series. Always keep Neutral and Ground wires separate to ensure no shorts occur.

**NOTE** – Neutral (NEU) in the E3-MAC Series is common to both the Input and Output. Never mix Neutrals for the building wiring (Non-Emergency) with the Emergency wiring. Dedicated wiring is required by NEC code ARTICLE 700.

## 4.4 Special Options

Custom units are available (Section 8 Specifications – Ordering Guide) and these may cause the construction to differ from standard models.

### **Output Circuit Breakers:**

Wires can be landed directly to the circuit breakers since these are UL489 type which are approved for field wiring.

### **Maintenance Bypass Switch:**

This option will have an input terminal block for landing the incoming AC feed wires. Connect the incoming AC feed to this terminal block.

### **Trip Alarms:**

This option uses an auxiliary contact on the side of the output breaker to indicate to the controls that the circuit breaker has tripped.

### **Switched Output:**

This option has a Switched Command which controls the Switched Output. Switched Outputs are provided with Circuit Breakers.

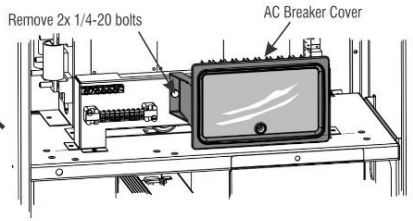
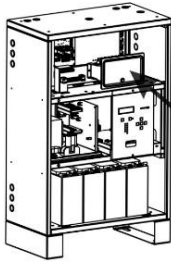

### Standard Output Terminal Block Illustration

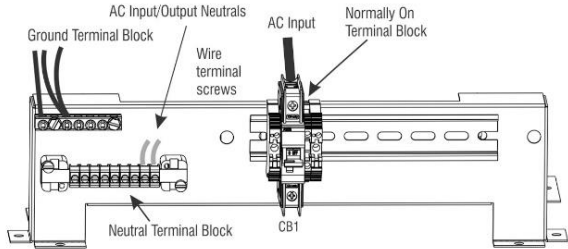

### Optional Output Circuit Breaker Illustration

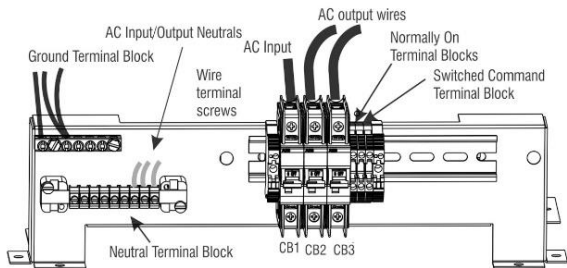

**SIZE 1** - Can accommodate up to 8 output breakers without trip alarms, 5 output breakers with trip alarms. Output circuit breakers can be configured as Normally-On, Normally-Off and Switched-Output types. See Ordering Guide in Section 8 for your specific breaker configurations. Breaker type(s) quantity may be limited due to other installed optional features.

## SIZE 1 1KW Model

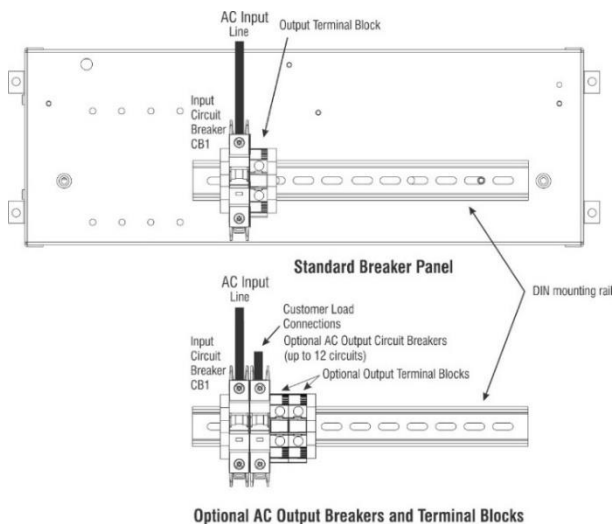
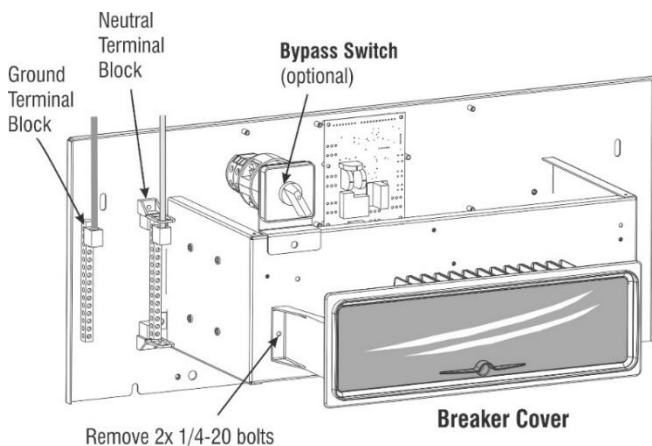

**SIZE 2** - Can accommodate up to 12 output breakers without trip alarms – 8 output breakers with trip alarms. Output circuit breakers can be configured as Normally-On, Normally-Off and Switched-Output types. See Ordering Guide in Section 8 for your specific breaker configurations. Breaker type(s) quantity may be limited due to other installed optional features.

## SIZE 2

### 1.6KW thru 3.0KW Models

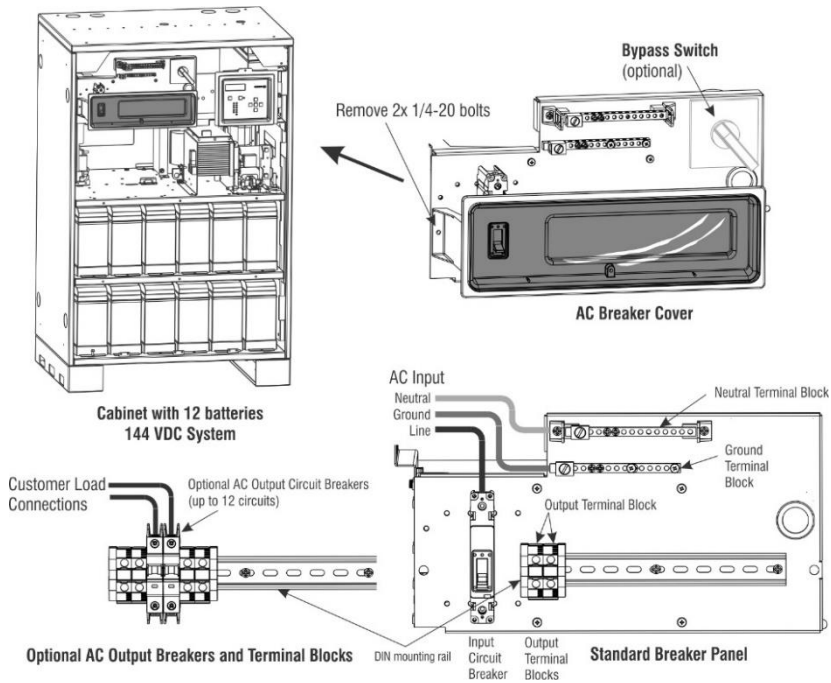

**SIZE 3** - Can accommodate up to 12 output breakers without trip alarms – 8 output breakers with trip alarms. Output circuit breakers can be configured as Normally-On, Normally-Off and Switched-Output types. See Ordering Guide in Section 8 for your specific breaker configurations. Breaker type(s) quantity may be limited due to other installed optional features.

## SIZE 3

**4.0KW thru 6.0KW Models**



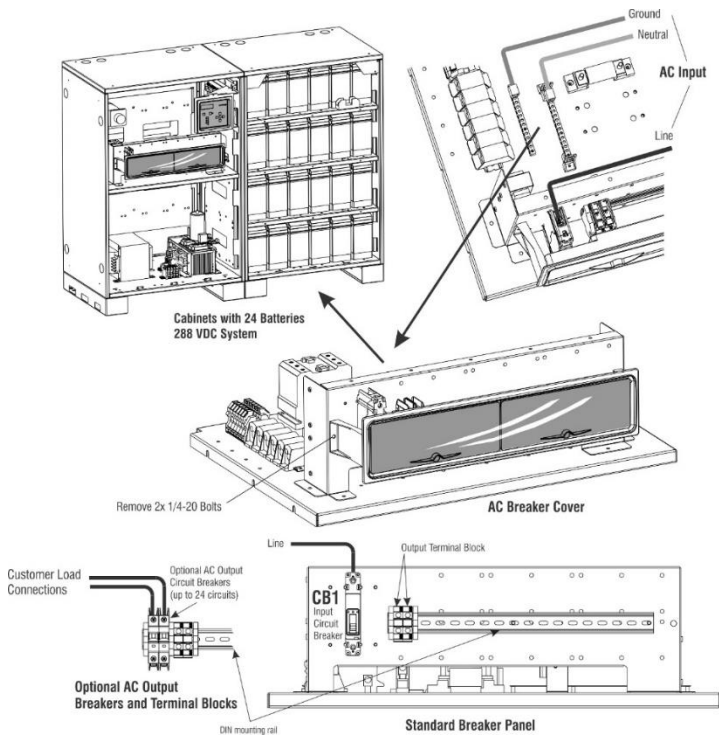

**SIZE 4** - Can accommodate up to 24 output breakers without trip alarms – 18 output breakers with trip alarms. Output circuit breakers can be configured as Normally-On, Normally-Off and Switched-Output types. See Ordering Guide in Section 8 for your specific breaker configurations. Breaker type(s) quantity may be limited due to other installed optional features.

## SIZE 4

*8.0 KW thru 12.5 KW Models*

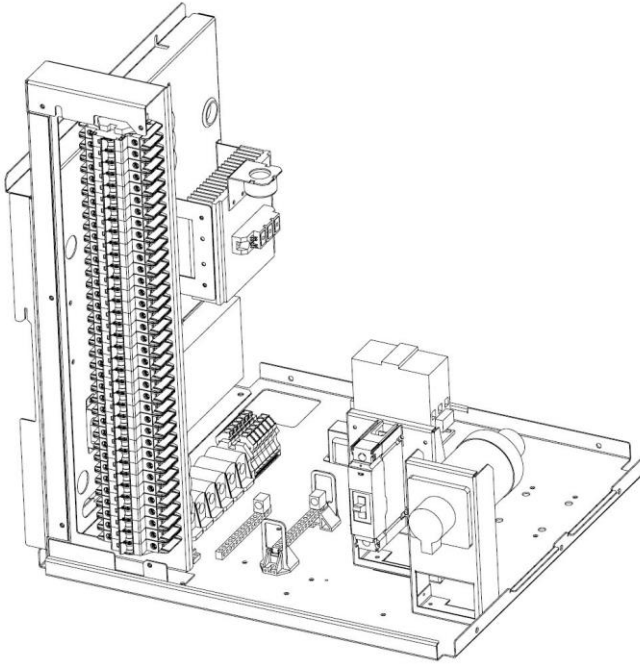

**SIZE 5** - Can accommodate up to 36 output breakers without trip alarms – 24 output breakers with trip alarms. Output circuit breakers can be configured as Normally-On, Normally-Off and Switched-Output types. See Ordering Guide in Section 8 for your specific breaker configurations. Breaker type(s) quantity may be limited due to other installed optional features.

## **SIZE 5**

### ***13.3 KW thru 17 KW Models***

## 5.0 BATTERY AND DC CONNECTIONS

**WARNING** – Only qualified personnel that are familiar with AC and DC installation techniques and codes (such as an electrician) should perform the Installation.

**WARNING** – Remove all rings, watches, and other jewelry before doing any electrical service or installation work. Always wear protective clothing and personal protective equipment (PPE) that is suitable such as eye protection when working near batteries.

**WARNING** - Batteries contain tremendous energy and can explode if short circuited. Precautions should be taken to eliminate possible short circuits. Do not install batteries until unit is completely mounted and secured in a permanent location with all conduit and AC wiring connected.

### 5.1 Battery Inspection

Inspect the batteries for any physical damage such as cracks or any other sign of leaking electrolyte. Batteries contain Sulfuric Acid which is highly corrosive. A leak from a battery will cause an unsafe condition.

### 5.2 Battery Installation/Removal

**Note** - Always ensure that the DC Fuse(s) are removed before starting installation.

1. Load all the batteries onto the shelves. Ensure proper spacing between the batteries so that Battery to Battery Jumper Bars can be installed (Step 4).
2. Connect Battery Cables that go from shelf to shelf.
3. Connect Battery Positive
4. Connect all Jumper Bars between batteries
5. Connect Battery Negative
6. Install Fuse(s) – see your model if applicable. Battery string fuses are required when separate battery cabinets are used.

To remove the batteries, simply reverse the above steps.

### 5.3 DC Voltage of System

The DC string voltage for the E3-MAC Series varies by size. The required string voltage is produced by connecting multiple 12V batteries in series. Please refer to the System Specifications for your model in Section 8.

## 5.3 Battery Hardware

All battery hardware required for the installation comes with the system. When installing the batteries and hardware, please ensure flat washers and lock washers are used with each bolt. Ensure that the batteries jumper busbars are seated flat against the surface of the batteries terminals before tightening and NEVER over-tighten the bolts by ensuring that proper torque is applied to the bolts.

## 5.4 Battery Pre-Checks

All batteries are quality controlled and measured from the factory before shipping. We recommend that additional measurements are made as a quick determination of the batteries health before starting up the system. Measure all batteries in their resting state and ensure that all batteries are within 0.10 VDC to 0.150 VDC from each other.

### Tools Required:

Torque Wrench  
w/10mm socket

**Note** - Torque all batteries to 100 in-lbs.

**Note** - Ensure all bolts contain the Flat Washer and Lock Washer on all the interconnect wires and buss bars.

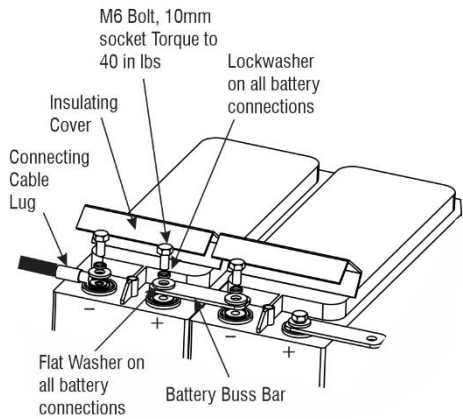

1KW  
MODEL

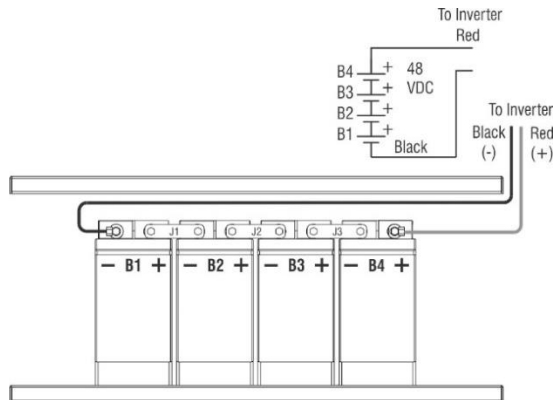

## Battery Connection - 48 VDC Systems

**1.6 KW  
MODEL**

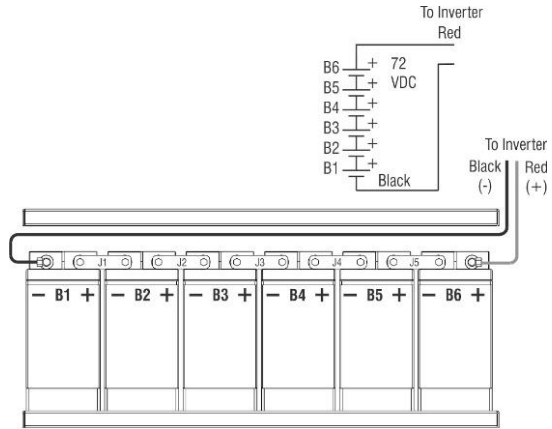

### Battery Connection - 72 VDC Systems

**2.2 KW  
4.0 KW  
MODELS**

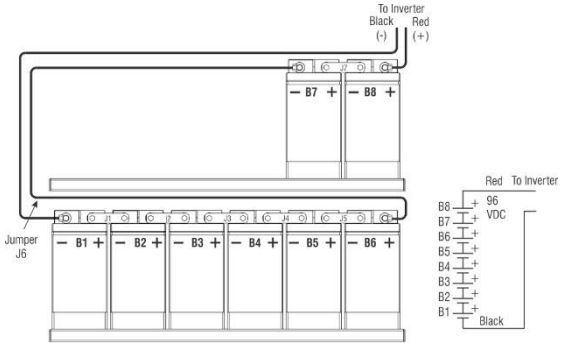

### Battery Connection - 96 VDC Systems

**2.8 KW  
5.0 KW  
MODELS**

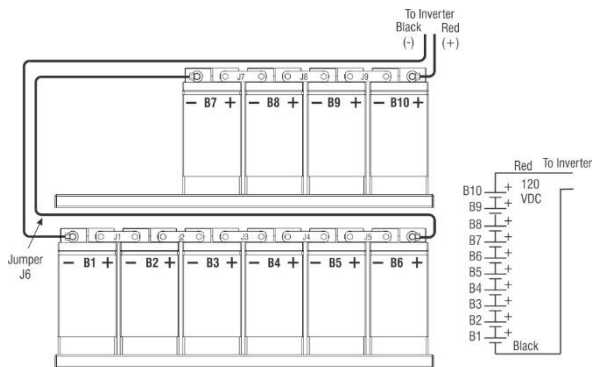

### Battery Connection - 120 VDC Systems

**3.0 KW  
6.0 KW  
MODELS**

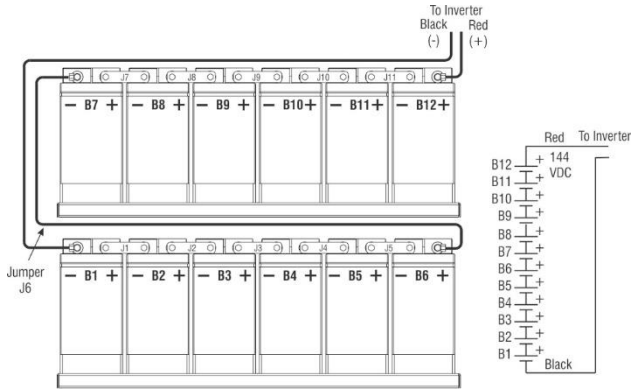

**Battery Connection - 144 VDC Systems**

**8.0 KW  
MODEL**

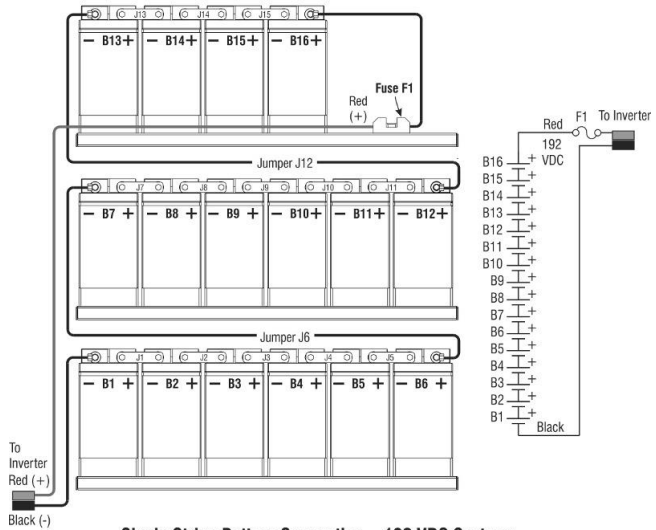

**Single String Battery Connection - 192 VDC Systems**

## 10.0 KW MODEL

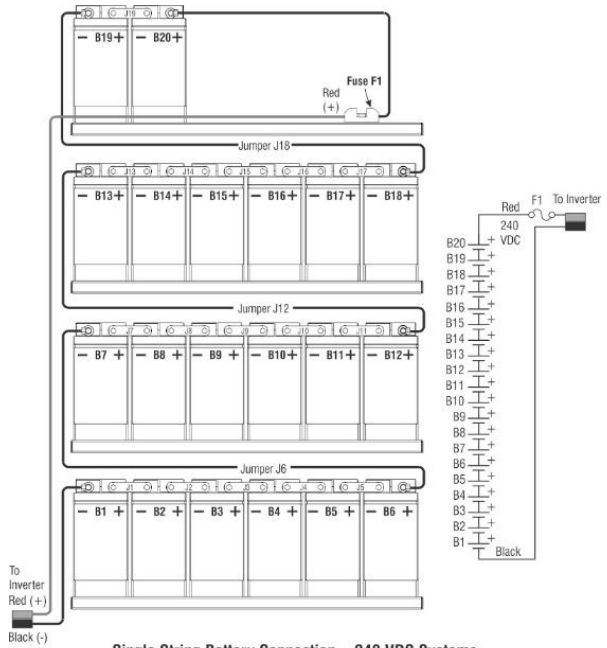

## 12.5 KW MODEL

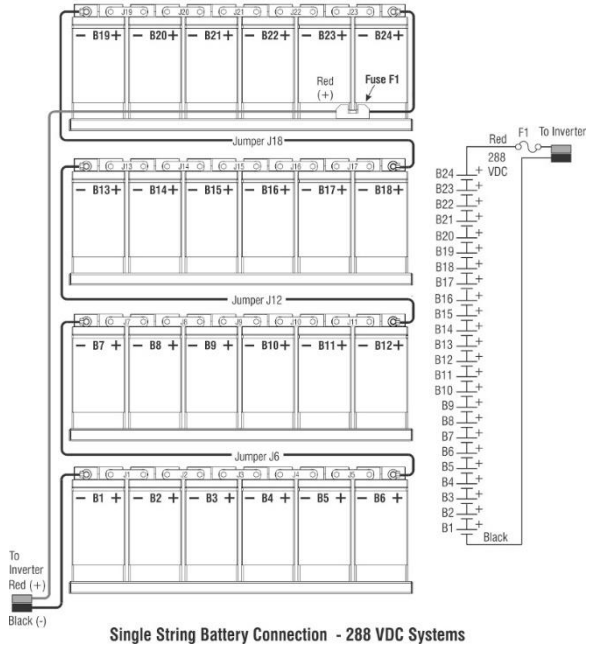

**13.3 KW  
MODEL**

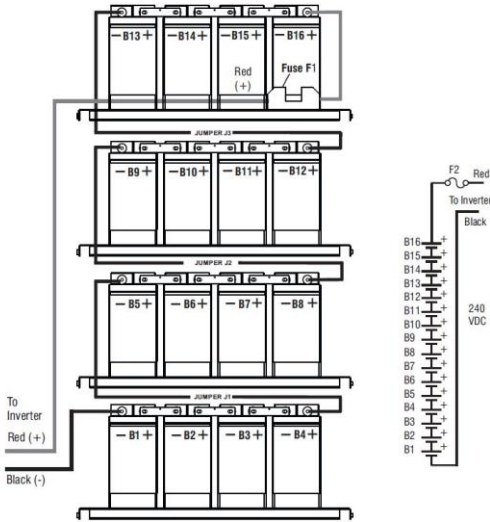

**Single String Battery Connection - 192 VDC Systems**

**17 KW  
MODEL**

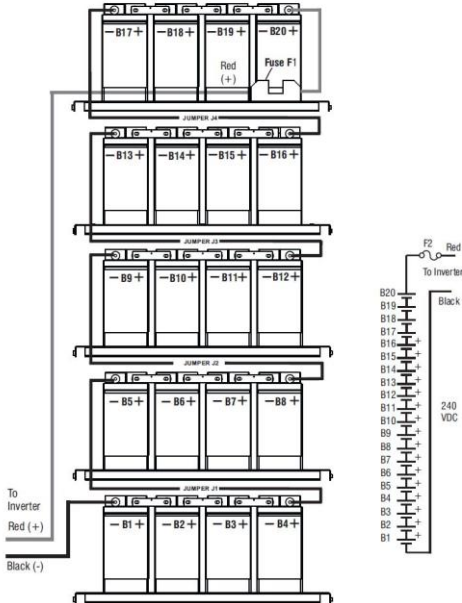

**Single String Battery Connection - 240 VDC Systems**



## 6.0 STARTUP AND SHUTDOWN PROCEDURES

### 6.1 Startup

After the unit is installed, the AC Input and Output wires landed and the batteries are installed and wired per Sections 3 - 5, the unit is ready to be started up. Ensure that the incoming AC voltage is reaching the unit by turning on all feed circuit breakers. Once AC input is verified, simply turn on the System ON/OFF switch. The unit will go through a series of diagnostics to verify proper connections and then will go into the charge mode. The unit is now on-line and ready. Verify that all load connections are operating within the specifications of the unit by measuring AC currents on both the incoming line and outgoing load and measure all neutral currents to ensure line and neutral currents are the same.

Press the Test button on the front panel to verify that all loads are operational and ensure there are no overloads by measuring all the load currents.

**If at any time you have questions – please consult the factory**

### 6.2 Shutdown

To completely shut the system down, switch the System ON/OFF switch to the OFF position. If the unit is shut down for a long duration, please see Battery Storage Section 2.2 to ensure that the batteries are not damaged from the effects of self-discharge and high ambient temperatures.

## 7.0 SYSTEM OPERATION

### 7.1 Startup Mode

When the E3-MAC Series is first turned on using the System ON/OFF switch, it goes through a sequence of self-tests which ensures proper connections are made and also checks for faults that may be present. The inverter must qualify several things before advancing to the Battery Charging mode. There will be two distinct clicks of relays as it goes through the self-check sequence. After all the Start-Up diagnostics are performed, the E3-MAC Series is OK to proceed to the Battery Charging mode.

### 7.2 Battery Charging Mode

The Battery Charging mode is where the system will remain for most of the products life. In this mode, AC power is being passed from the INPUT AC through to the OUTPUT AC and subsequently its loads are being powered and the internal battery charger is maintaining a float charge. The charger is regulating or floating the batteries at 2.26 Volts per Cell (VPC) and is temperature compensated to 4mV per deg. C (per cell),

centered at 25 °C. For higher temperatures, float voltages go down. For lower temperatures, float voltages go up.

## 7.3 Inverter Mode

Inverter Mode can have several other names such as Emergency Power and Battery Power Mode. This terminology may be used throughout this document.

During Inverter Mode, the inverter is producing a pure sine wave for the output loads and the batteries are being discharged. The output current is limited by an active pulse by pulse current limit technique and prevents the inverter from failure.

In the event of an overload there are several ways that the inverter will protect itself. First is the pulse-by-pulse limit and second is by average sensing. The pulse-by-pulse is a transient protection and occurs in the micro-second time scale, the average sensing looks at a heavily filtered signal and occurs in the seconds time scale.

Due to the high crest factor on the E3-MAC Series, loads that have high inrush currents are quickly up and running. This is very beneficial with Switched or Normally-Off loads. The Normally-On and multipurpose Normally-Off/Switched outputs all produce voltage during Inverter Power mode.

## 7.4 Normally-On Output

There is one Normally-On Output located on the terminal block and is labeled N-ON. The Normally-On Output is energized 24/7 as long as the system is powered on.

## 7.5 Normally-Off/ Switched Output

Normally-Off outputs are energized only during an Emergency condition or when the system test button is pressed.

Switched outputs are controlled by applying an AC voltage to the Switched Command. These output types function as an interface to energy saving controls such as time clocks, daylight harvesting, photo-sensors, occupation sensing or lighting control systems.

**NOTE** - When the E3-MAC Series changes mode of operation from Charge Mode to the Inverter Mode, **ALL** output types will automatically energize regardless of the state of the Switched Command Input.

## 8.0 Specifications

### Input

Voltage	Model and Voltage Dependent (Table 8.1)
Current	Model and Voltage Dependent (Table 8.1)
Frequency	60Hz +/- 2 Hz
Protection	Input Circuit Breaker standard
Power Factor	0.5 lead to 0.5 lag

### Output

Voltage	Model and Voltage Dependent (Table 8.1)
Current	Model and Voltage Dependent (Table 8.1)
Frequency	60Hz +/- 0.02 Hz crystal controlled during emergency mode
Overload	110 percent will generate overload fault 125% will generate overload shutdown
Transfer Time	2mS standard (User programmable to 50mS)
Output Distortion	Less than 3% THD
Crest Factor	4X minimum on all models
Load Power Factor	0.5 lead to 0.5 lag
Output Types	1x Normally-On Standard – Normally-Off/Switched optional

### Battery

Type	Premium Long Life Valve-Regulated Lead Acid (VRLA)
Charger	3 rate with Temperature Compensation
Recharge Time	24 Hour recharge standard
Protection	Automatic Low Voltage Disconnect (LVD) set at 1.67 VPC Automatic restart upon utility return
Runtime	90 Minutes at 25 °C
DC Voltage	Model and Voltage Dependent (Table 8.1)
DC Current	Model and Voltage Dependent (Table 8.1)

### Environmental

Operating Temp	20 to 30 °C
Storage Temp	-20 to 70 °C (Electronics) 0 to 40 °C (Batteries)
Relative Humidity	<95 % (non-condensing)

### Physical

Cabinet	NEMA Type 1 enclosure, 14 AWG powder painted CRS
Cooling	Natural Convection – No fans during float charge Forced Convection – Fans used during Inverter Mode of operation
Size/Weight	Model and Voltage Dependent (Table 8.1)

	E3MAC-1000	E3MAC-1600	E3MAC-2200	E3MAC-2800	E3MAC-3000	E3MAC-4000	E3MAC-5000	E3MAC-6000	E3MAC-8000	E3MAC-10000	E3MAC-12500	E3MAC-13300	E3MAX-17000
Power Output (WVA)	1000	1600	2200	2800	3000	4000	5000	6000	8000	10000	12500	13300	17000
Typical Standby Efficiency (%)	0.98	0.98	0.98	0.98	0.98	0.98	0.98	0.98	0.98	0.98	0.98	0.98	0.98
Power Factor Load Range (Lead/Lag)	0.5/0.5	0.5/0.5	0.5/0.5	0.5/0.5	0.5/0.5	0.5/0.5	0.5/0.5	0.5/0.5	0.5/0.5	0.5/0.5	0.5/0.5	0.5/0.5	0.5/0.5
Voltage Output (VAC)	120/277	120/277	120/277	120/277	120/277	120/277	120/277	120/277	120/277	120/277	277	277	277
Current Output (IAC)	8.3/5.6	13.3/5.8	18.3/7.9	23.3/10.1	25/10.8	33.3/14.4	41.7/18.1	50/21.7	66.7/28.9	36.10	45.10	48.00	61.40
Voltage Output THD Max (%)	3%	3%	3%	3%	3%	3%	3%	3%	3%	3%	3%	3%	3%
Battery Nominal (VDC)	48	72	96	120	144	96	120	144	192	240	288	192	240
Battery Qty	4	6	8	10	12	8	10	12	16	20	24	16	20
Battery Current (IDC)	23.5	26	26	26	22.4	44.8	44.8	44.8	44.8	44.8	46.7	74.5	76.2
Battery Type (PN)	8250022	8250022	8250022	8250022	8250022	8250023	8250023	8250023	8250023	8250023	8250023	8250024	8250024
System Weight (lbs.)	343	549	627	705	783	1060	1220	1380	2020	2340	2660	3200	3700
Power Input (full output, max charge)	1250	2000	2750	3500	3750	5000	6250	7500	10000	12500	15625	16625	21250
Voltage Input	120/277	120/277	120/277	120/277	120/277	120/277	120/277	120/277	120/277	277	277	277	277
Current Input (full output, max charge)	10.5/4.6	16.7/7.3	23/10	29.2/12.7	31.3/13.5	41.7/18.1	52.1/22.6	62.5/27.1	83.3/36.1	45.1	56.4	60	76.7
Suggested Circuit Breaker Feeder Rating (IAC)	20/20	30/20	30/20	40/20	50/20	60/30	70/30	90/40	120/50	60	80	80	100
Emergency Runtime at full load (minutes)	90	90	90	90	90	90	90	90	90	90	90	90	90
Maximum BTU losses during standby	70	110	150	190	220	285	355	425	560	715	850	907	1160
Maximum BTU losses during Emergency Discharge	580	650	900	1050	1150	1500	1750	1950	2950	2800	3200	3400	4347

**Note:** This unit has brown-out circuitry which causes automatic transfer to Inverter Mode when AC input drops below 85%.

**Table 8.1**  
Unit Specifications

ISOLITE						
Battery Usage by Product Line - Acid Weight and Electrolyte Volume						
Inverter Series	Inverter Model	Wattage	Battery Used	Pure Sulfuric Acid (lbs)	Electrolyte Volume(Gal)	Battery Qty
E3 Series Inverters Single Phase	E3MAC-1000-1P	1KW	B250022	13.04	2.72	4
	E3MAC-1600-1P	1.6KW	B250022	19.56	4.08	6
	E3MAC-2200-1P	2.2KW	B250022	26.08	5.44	8
	E3MAC-2800-1P	2.8KW	B250022	32.6	6.8	10
	E3MAC-3000-1P	3.0KW	B250022	39.12	8.16	12
	E3MAC-4000-1P	4KW	B250023	43.2	9.04	8
	E3MAC-5000-1P	5KW	B250023	54	11.3	10
	E3MAC-6000-1P	6KW	B250023	64.8	13.56	12
	E3MAC-8000-1P	8KW	B250023	86.4	18.08	16
	E3MAC-10000-1P	10KW	B250023	108	22.6	20
	E3MAC-12500-1P	12.5KW	B250023	129.6	27.12	24
	E3MAX-13300-1P	13.3KW	B250024	137.6	28.96	16
	E3MAX-17000-1P	17.0KW	B250024	172	36.2	20
<b>B250022 (LPF12-55) - 3.26 lbs. of pure sulfuric acid, 0.68 gal. of electrolyte each</b>						
<b>B250023 (LPF12-100A) - 5.40 lbs. of pure sulfuric acid, 1.13 gal. of electrolyte each</b>						
<b>B250024 (LPF12-160) - 8.6 lbs. of pure sulfuric acid, 1.81 gal. of electrolyte each</b>						

**Table 8.2**  
Battery Electrolyte Volume

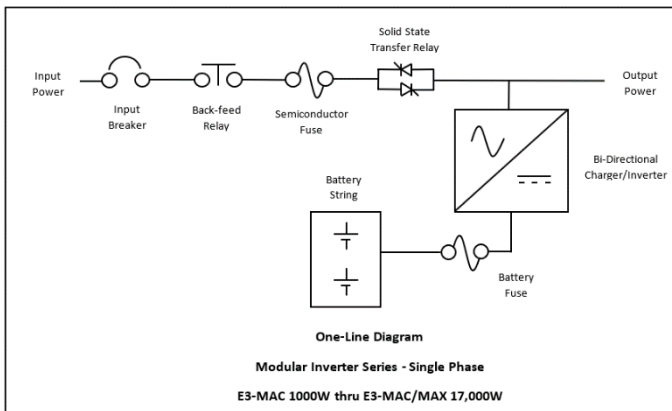

**Diagram 8.3**  
System One-Line Drawing

## 9.0 WARRANTY

There are two separate warranty periods for the E3-MAC Series Central Inverter System. The Electronics/Cabinet warranty period is for 2 years from the date of shipment. It is warranted against defects in workmanship and materials under normal and proper use. Batteries are covered under a separate warranty and these durations may change dependent on battery type.

**BATTERY TYPE**  
Standard VRLA

**WARRANTY DURATION**  
1 year full, 9 years pro-rata

## 9.1 Technical Service and Support

Our technical support staff is available before, during, and after the installation for help on any detail of this product. Should you need help, please contact our service center at:

**Service Center**

**1-800-967-5573**

Available during normal business hours Eastern Standard Time Zone.

## 9.2 Return Material Authorization (RMA)

At no time will material be accepted as returned goods without a RMA number issued from the factory. If parts are deemed defective by our Technical Service group and are troubleshot at the site to be defective, they can be exchanged at no cost during the warranty period with an RMA.

When returning defective parts back to the factory, the RMA number must be written on the packaging, bill of lading, or shipping labels so it can be properly identified.

Technical Service will make every effort to troubleshoot the problem over the phone before an RMA will be issued. Phone troubleshooting may save both the customer and manufacturer added time and expense. Cooperation is greatly appreciated.

# 10.0 MAN MACHINE INTERFACE (MMI)

## 10.1 Introduction

The Front Panel Man Machine Interface (MMI) consists of a 5 button keypad (Left Key, Up Key, Right Key, Down Key and Enter Key) for menu navigation, a 4x20 character backlit LCD display, Heads-Up LEDs for quick diagnosis of system status and alarms, Dedicated System Test pushbutton and Alarm Silence On/Off pushbutton. There is also an SD card for downloading the Logs to transfer to a computer for analysis.

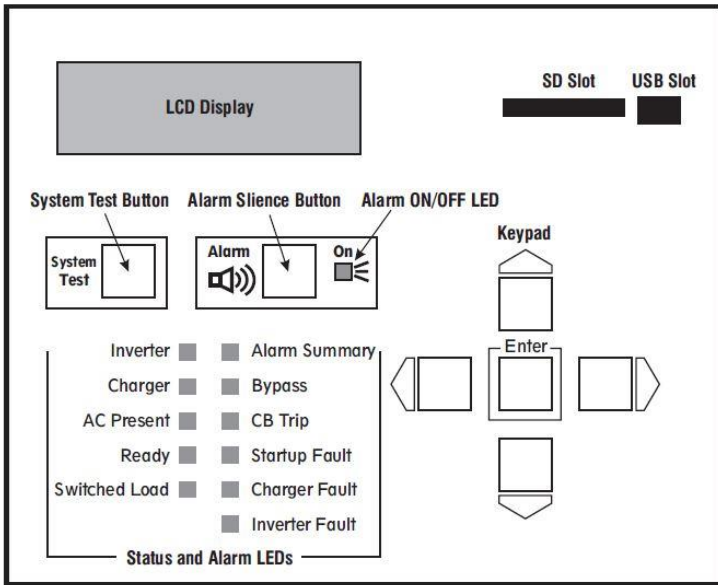

## Man Machine Interface (MMI)

Figure 10.1 – MMI Front Panel Interface

## 10.2 System Test Button

Pressing the System Test pushbutton will initiate a 30 second test of the system. This test will comply with the UL924 self-testing and self-diagnostics by analyzing battery voltages and output loads. All switched loads are energized during a system test.

## 10.3 Alarm Silence Button

Pressing the Alarm Silence button will silence the audible alarm and also turn off the Alarm On/Off LED. The Alarm Silence is equipped with a “ring-back” feature so that if an alarm is still present 24 hours after the alarm is silenced, the audible alarm will re-activate.

During a System Test and also during a power outage when the system is on Inverter Power, the audible alarm will beep momentarily once every second.

## 10.4 Keypad and Display Features

Using the Keypad and 4x20 Display, the user can access all features of the system including Meter Measurements, User Settings, Test Logs, Alarm Logs, Event Logs, System Info, Alarms and System Info. The Home Menu is a scrolling menu that scrolls between the Company and Product information on one page and then the Date and Time and Alarms (if Present) on another page. To Leave the Home Menu, Press the Enter (center) Button. From there press the down arrow to scroll down to see the available menus.

## 10.5 SD Card

The SD card slot is available for downloading all the Test, Event and Alarm Logs as a backup to a computer for analysis or record keeping. To initiate the SD card storage feature, the user must do so through the User Menu so it is password protected. Please see the Backup Logs in the User Menu 10.13 for instructions for this process.

## 10.6 USB Slot

The USB slot is not available to the User and is available only to Factory or Qualified Field Service Technicians. Its purpose is for system updates such as software and critical system parameter changes through a file structure and internal flash memory drives.

## 10.7 Main Menu

The Main Menu is the First Menu available after the Home Page that Automatically Scrolls between Company info and Date and Time. The Main Menu consists of sub-menu selections and are Meter Menu, Alarms, Event Log, Test Log, Alarm Log, User Setup, Factory Setup and System Info. To reach the Main Menu, simply press the Enter button from the Home Page. Then use the up and down arrow key to select between all the Sub-Menus previously listed and once the desired Sub-Menu is reached, simply press the Enter Key to access that Sub-Menu for immediate entry.



## 10.8 Meter Menu

The following 11 functions are available through the Meter Menu.

Input Voltage, Output Voltage, Output Current, Output VA, Battery Voltage, Battery Current, Battery Power, Temperature, System Days, Inverter Minutes and Inverter Events. Output Voltages and Currents are True-RMS measurements while Battery measurements use an Averaging technique. The Measurements are updated on the MMI screen approximately every half second and are of high resolution and near instrument quality. All system parameters are calibrated from the factory and are done so at full scale.

## 10.9 Alarm Menu

If alarms are present, the active alarms will be displayed in the Alarm Menu. If no alarms are active, the display will read Alarms (0). There are many alarms that the system can diagnose. Some alarms are fixed, and some are programmable through the User Menu.

Fixed alarms are not user adjustable nor can they be turned on or off – they are always active and are imperative for proper safeguarding and operation of the system. The factory has broken down these alarms into three modes of operation which are Startup, Charger and Inverter modes. The possible fixed alarms are Startup Alarms (Communication, Setup Conflict, Battery Voltage, Back-Feed, Transfer /AC Fuse, Overload, Miswire, Incorrect AC), Charger Alarms (Communication, Over-Temperature, DC Fuse, No Charge, Overcharge, Back-Feed, AC Fuse/Wiring, Program Reference), Inverter Alarms (Communication, Over-Temperature, Overload, Crest Factor, V-Out, Back-Feed, Low Battery, Program Reference), Phase Rotation, CB Trip, UPS Bypass, Overload, and Overload Shutdown.

User programmable alarms include Low Battery, Near Low Battery, High Temperature, Utility Failure, Low VAC, High VAC and Load Reduction. These can be turned on and off and adjusted through the User Menu.

The system is provided with an Inrush alarm to detect high inrush current associated with modern lighting loads. This feature is factory adjustable and if this alarm occurs, please consult factory for troubleshooting the connected load.

Further explanation of Alarms and possible causes shall be explained throughout this document.

## 10.10 Event Log

An Event is when the System transfers from Battery Charging mode (99.9% of life) over to Emergency Power and starts to discharge the battery. This occurs when a system test is initiated or when a power outage occurs. During an event, the system keeps a record of critical parameters such as Time and Date of the event, Output Voltage, Current, VA, Battery Voltage, Battery Current and Battery Power. Since the system is constantly measuring these parameters, it stores the Beginning of the Event and the End of the Event and saves this information in a file. Up to 100 Events can be stored before memory will start to overwrite the oldest event so the process is First In – First Out and event #1 will always be the newest.

## 10.11 Test Log

Identical to the Event Log with the exception that the Test Log is only stored when a system test is either:

- a) initiated from either a manual process of the User pressing the Test Button on the front panel keypad or,
- b) when the system is instructed by the automatic monthly or yearly test.

## 10.12 Alarm Log

In the event an alarm occurs from one of many that the system can produce, this alarm is immediately stored into memory. The alarm log has a record of any and all alarms the system has experienced and is valuable for troubleshooting and detecting issues. The Alarm Log is stored in a First in – First out process just like the other logs and has the capability of storing up to 1000 alarms.

## 10.13 User Menu

From the Scrolling Home Pages, press Enter Key and down arrow to select User Menu and press Enter to get to the password entry screen. **The User Password is 4 keystrokes - Left Key, Right Key, Left Key, and Right Key.** Upon successful password keystrokes, the User Menu is accessible and now several alarms can be turned on/off and threshold levels for these alarms can be changed. If the password keystroke was not successful, the Enter Password will be prompted again and the user has the option of going back with the left key to try again.

### Date and Time

The date and time is preset from the Factory (East Coast Time), user adjustable and battery backed up. The Date and Time are extremely accurate and have a couple second per year gain/loss accuracy. All Test, Event and Alarm Logs are time stamped from the machines date and time settings. Furthermore, all Month and Year Tests are synchronized to the machines date and time settings, so it is imperative that the correct date and time are set. Daylight savings time is not compensated for so in the event your area observes daylight savings time, please change the machines time for most accurate settings.

### Month Test

Per the NFPA and UL requirements, a system test of the Emergency Lighting equipment should be performed once per month. Which Day of the month and what time of day are fully adjustable. Factory default is First Day of month at 8:30 AM the test will be performed.

### Year Test

In addition to the Month Test requirements of the NFPA and UL, it is mandated that a 90-minute discharge be performed once per year. The Month, Day and Time of this test is fully adjustable and the Factory default for this test is off. If the Yearly test is enabled, the system will undergo a full 90-minute discharge test at the time and date determined by the settings.

### **Low VAC Alarm**

User can enable or disable this alarm by selecting the up or down arrow keys to “On” or “Off” and then press the Enter Key. If the user enables this alarm, the default setting is 85 percent of nominal AC line voltage but is fully adjustable. Using the up or down key, adjust the voltage to the desired level. There are high and low limits to this alarm and are within the range 100 percent to 60 percent respectively. Low VAC Alarm factory default setting is off.

### **High VAC Alarm**

This alarm works just like the Low VAC alarm so it can be enabled or disabled and adjusted however, the default setting for this alarm is 115 percent of nominal AC line voltage. The high and low limits are 140 percent and 100 percent respectively. High VAC Alarm factory default setting is off.

### **Low Battery Alarm**

Low Battery alarm is Factory Enabled and is set to 85 percent of battery nominal DC voltage. For a 48VDC system, this translates to approximately 40.8VDC. This alarm level can be user changed and is adjustable from Nominal to 85 percent of nominal which translates to 40.8V for a 48VDC system.

### **Near Low Battery Alarm**

Near Low Battery alarm is Factory Enabled and is set to 98 percent of battery nominal. For a 48VDC system, this translates to approximately 47VDC. This alarm level can be user changed and is adjustable from Nominal to 85 percent of nominal which translates to 48V to 40.8V for a 48VDC system.

### **Utility Failure Alarm**

This alarm can be turned on and off and has no threshold levels. Factory Default setting for this alarm is off.

### **High Temperature Alarm**

The system has an internal temperature sensor. The system temperature may be a bit higher than ambient temperature – please keep this in mind if using the High Temperature Alarm. The High Temperature alarm is adjustable from 0 °C - 60 °C and is activated when the temperature goes above this level. Factory default for this alarm is off and if enabled will immediately default to 40 °C (about 104 degrees F.)

### **Time Delay**

Time Delay is a feature that keeps the switched loads on for the duration of the Time Delay setting. If Time Delay is set to off, the switched outputs will immediately go off upon event ending (Power Loss or System Test). If Time Delay is set to 10, the switched loads will remain energized for 10 minutes after power has been restored. This feature is useful when there are HID (High Intensity Discharge) lights on the site and these lights have a re-strike time before they can be turned on again due to the cooling process. The factory default setting for this is off but can be User Adjusted up to 15 minutes.

## **Load Reduction Alarm**

Load Reduction is an alarm available to quantify if Load Changes have occurred. When the Load Reduction option is enabled, the actual output current is compared to a user adjusted load current setting during an event only! It only looks at load current during an event because with modern lighting management, the loads can continuously change from Motion Sensors, Occupancy Sensors, etc. These constant load changes may trigger an alarm but, the system is operating as designed. When the Actual Output Current deviates more than 10 percent high or 10 percent low from that Load Current Setting, an alarm will be tripped. The factory default for this setting is off and if enabled the adjustment for the load current setting is from zero amps to system full scale current in 0.1A increments.

## **Relay 1**

A user programmable alarm function or status function can be tied to a Form-C relay to integrate into a building management system. The relay can be triggered on the following status or alarm features – AC Present, Battery Charging, Inverter On, High Temperature, Utility Failure, Near Low Battery, Low Battery, High VAC, Low VAC and Relay Off. The factory default setting for Relay1 is off.

## **Relay 2**

Identical to Relay 1 in function. Relay 2 is an independent relay with its own Form-C contacts.

## **Backup Logs**

To use the Backup Logs function, an SD card must be inserted into the SD card slot. When the Backup Logs function is selected, ALL internal logs from Test Logs, Event Logs, Alarm Logs and Discharge Logs will be written to the SD card. The files that are stored are Text files for each individual log and may consist of thousands of files. This process may take several minutes to finish due to the limitations of the internal processor speed and all of the tasks that it is simultaneously performing.

## **Contact Name**

A Contact Name can be entered into the system for storage. The contact name is then viewable in System Info. The Name can be changed using the keypad by scrolling through the alpha/numeric selections with the up and down arrow keys. When the correct number or letter is reached, scroll left or right for the next character or press Enter when finished.

## **Contact Phone**

A Contact Phone Number can be entered into the system for storage. The contact phone number can be viewed in the System Info. The Contact Phone number can be changed using the keypad by scrolling through the alpha/numeric selections with the up and down arrow keys. When the correct number or letter is reached, scroll left or right for the next character or press Enter when finished.

## 11.0 MAINTENANCE AND SERVICE

**CAUTION** – Whenever maintenance and service is to be performed, it may be desirable to shut the unit down. Please refer to Start up and Shut Down procedures for details.

**CAUTION** – Always assume AC and DC Voltages are present at the E3-MAC Series terminals because the inverter is capable of providing output voltage from the batteries when there is no AC input present. The unit will pass AC voltages from the AC input to AC output if the system ON/OFF switch is ON.

### **Routine Maintenance**

Routine Maintenance should be considered any maintenance that does not require removing the Inverters' front cover panel. This maintenance includes periodic cleaning of dust from the cover and cabinet base to ensure proper convection air flow. Since no fans are required during float charge on this system, air flow moves by convection. Convection air circulation is from bottom to top as heat naturally rises.

Keep all foreign objects off the top and away from the sides of the unit as these may impede convection air flow.

E3-MAC Series automatically performs monthly tests which is fully programmable. A quick test by manually pressing the test button will transfer the system to the Inverter Mode and will turn on all the connected loads such as the multipurpose Normally-Off/Switched load.

Ensure there are no faults present. If there are faults, please refer to the User Interface 10.13 for a complete detail of what this fault may indicate.

**Monthly Test** - By pressing the TEST button on the front panel, the unit will transfer to the Inverter Mode. This test will run for at least 15 seconds and will exit back to Battery Charging upon synchronizing to utility power.

**Yearly Test** - The NFPA code requires that a yearly test of 90 minutes be performed and the system must be able to run the full 90 minutes without going into a LVD fault.

A yearly test of 90 minutes can be initiated by holding in the TEST button for 5 seconds. An alternate method of performing the 90-minute yearly test would be to turn off the input feed breaker for the 90 minutes and then re-apply when the 90-minute duration is complete.

## 11.1 Battery Maintenance

The batteries used in the E3-MAC Series are sealed lead calcium and are termed "Maintenance Free". This term may be misleading because ALL batteries require periodic maintenance even if it only consists of a visual inspection. We recommend the following maintenance plan:

- Once every 6 months the batteries should be visually inspected for cracks, leaks, bulging or deformities and corrosion buildup on terminals.

## 11.2 Battery Replacement

E3-MAC Series is a UL approved and listed component with exact battery requirements. Failure to replace the batteries with the exact same type will VOID the UL approval. For battery replacement, please call the service number listed in Section 9 Warranty so that the unit performs as it was intended.

To remove the batteries, shut the unit completely down by turning off the System ON/OFF switch and remove AC power Feed source by turning off the input circuit breaker. Disconnect the Battery Connector from the PCB before removing the inverter assembly. Remove the Inverter Assembly by removing the 4 nuts that attach it to the cabinet. Carefully remove the connectors from the batteries, remove the battery brackets with a nut driver or socket extension and then lift the batteries out of the cabinet.

**TIP** – If the batteries are to be replaced, discharging the batteries by running in the Inverter Mode can be beneficial. First, it verifies the batteries need replacing if it does not make 90 minutes of discharge time. Second, it depletes the battery which reduces the fault current. By running the battery to LVD, the available fault current would be substantially less and safer if an inadvertent short circuit were to happen during the removal or transportation process to the recycling facility.

**WARNING** – Only qualified personnel that are familiar with AC and DC installation techniques and codes should perform the removal and replacement.

**WARNING** – Remove all rings, watches, and other jewelry before doing any electrical service or installation work. Always wear protective clothing and appropriate personal protective equipment (PPE) that is suitable such as eye protection, etc. when working with batteries.

**WARNING** - Batteries contain tremendous energy and can explode if short circuited. Precautions should be taken to eliminate possible short circuits.

**WARNING** – Batteries contain lead. Follow all local and state requirements for battery disposal. Please dispose of properly by recycling.

**WARNING** – Always use the correct tools with insulated handles and wear the appropriate personal protective equipment (PPE) required for battery work.

### **DO NOT TOUCH BATTERIES UNLESS TRAINED OR KNOWLEDGEABLE!**

All means must be taken to prevent an inadvertent short circuit - ensure that all lugs are secure and insulated after removal from the batteries post. If the short circuit creates a welded lug so that the short circuit remains conducting current, the battery may explode.

Extreme danger and bodily injury can be caused by primary and secondary effects of the short circuit. Primary effects could include burns, vision or hearing loss. Secondary effects could be falling off a ladder or other sustaining injuries.

To install new batteries, see Section 5.0 Battery and DC Connections.

## 12.0 WEB INTERFACE

The E3-MAC Series Emergency Lighting Inverter comes standard with capability to connect to the web for access to all the system logs and programmable features. To logon to the E3-MAC, simply go to [Isolite.com](http://Isolite.com) and click on the Inverter Monitoring link under the Resources drop-down menu and follow the User Setup instructions below.

### 12.2 User Setup:

User Account set up requires a valid Central Inverter System serial number to setup an account. With a verification of a valid serial number the following information is required for the user to finish setting up the account:

Customer Name, Username, Password, Address (up to 2 lines), City, State, Country, Phone1, Phone2 and Email address.

- This information is required for the Factory to Verify and Authenticate the account. If account information is not valid, the factory will remove account and deny access to machines.

Once the user has gone through this account setup process, they can access critical information on their system by logging into their account and clicking on the Control Panel icon for their machine.

#### Control Panel (System Home) Page

The Control Panel acts as the Systems Home Page. From this page, it is possible to see several critical functions listed below plus several icons will link the user to many more features.

Meter Functions – Input Voltage, Output Voltage, Output Current, Output VA, System Battery Voltage, Battery Current (charging and discharging), Battery Power, System Temperature, System Days, Inverter Minutes and System Events.

Also included in the Control Panel is the System Status and include indicators for Battery Charging, Inverter Power On, AC Present, System Ready, and Switched Load Energized. The Alarm Summary indicator and critical alarms indicators include Unit in Bypass, Circuit Breaker Trip, Startup Fault, Charger Fault and Inverter Fault.

A System Test can be initiated by an icon located on the Control Panel. Immediately after pressing this Icon, the system will perform a system test and when complete will record test parameters in the Test Log. Please see System Logs for details.

From the Control Panel Page the user has access to several links and include User Setup, Alarms, Charts and Graphs and System Logs. Just click on the icons on the home page to access these features.

## User Setup Page

The user can change system parameters along with alarm trigger points and enable/disable alarms. The following features can be changed by the user: Date and Time settings(Year, Month, Day, Hour, Minute), Month Test Settings(Day, Hour, Minute) enable/disable, Year Test Settings(Month, Day, Hour, Minute) enable/disable, Low VAC Alarm enable/disable and set-point, High VAC Alarm enable/disable and set-point, Low Battery Alarm enable/disable and set-point, Near Low Battery Alarm enable/disable and set-point, Utility Failure Alarm enable/disable, High Temperature Alarm enable/disable and set-point, Time Delay setpoint (0-15 minutes), Load Reduction enable/dis-able and set-point, Relay 1 and Relay 2 activation event (Low VAC Alarm, High VAC Alarm, Low Battery Alarm, Near Low Battery Alarm, Utility Failure Alarm, High Temperature Alarm, Inverter On, Battery Charging and AC Present), Contact Name up to 20 characters, Contact Phone up to 20 Digits.

## Alarms Page

All possible system alarms are listed on the Alarms Page. If the Alarm is active, a Red indicator will be present next to the alarm function. This aids in troubleshooting the system and pin-pointing issues that may arise during the life of the product.

The following Alarms can be displayed:

Inverter Alarms – 8 distinct alarms including Communication, Over-Temp, Overload, Crest-Factor, Out of Range Output, Back-Feed, AC Fuse/Wiring, Programming Reference.  
Charger Alarms – 8 distinct alarms including Communication, Over-Temp, DC Fuse, No Battery Charge, Overcharge, Back-Feed, AC Fuse/Transfer Device, Programming Reference.

Startup Alarms – 8 distinct alarms including Communication, Setup Conflict, Battery Voltage, Back-Feed, AC Fuse/Transfer Device, Overload, Mis-Wire, Incorrect AC Phase Rotation, Circuit Breaker Trip, Unit in Bypass, Inrush Alarm, Low Battery, Near Low Battery, High Temperature, Overload, Overload Shutdown, Utility Failure, Low VAC, High VAC, Load Reduction

## Charts and Graphs Page(s)

Since all critical data is taken every second from the inverter, real-time information such as Meter and Status and Alarms are all live 24-7. This capability enables real-time monitoring of certain critical data and present it for analysis.

The Following charts are available and can be graphed in month or day format along with the capability of downloading files for alternate charting and graphing or simply just storage – this is only limited to the users imagination of what to do with the data.

## Temperature

Graphed in Degrees Centigrade, useful for knowing battery history and proper float voltage monitoring. Graph can be scaled to Days (28-31) by choosing the Year and



Month, or Hours (24) by choosing the Date. A popup calendar or numeric selector will appear when choosing time fields to adjust chart time scale.

### **Output VA**

Graphed in Min (Minimum) and Max (Maximum) readings for each hour and day. Min and Max values of Output VA can be selected/un-selected by mouse click and cause the graph to show both records simultaneously or one record at a time.

Similar to Temperature, the graph can be scaled to Days (28-31) by choosing the Year and Month, or Hours (24) by choosing the Date. A popup calendar or numeric selector will appear when choosing time fields to adjust chart time scale. Since this chart is a 3-D column chart, an adjustment of the Alpha Angle and Beta Angle can be adjusted for optimum viewing.

### **Battery Voltage**

Graphed in hours, this chart is the highest resolution and also is a Zoom-able type chart. If a discharge event has occurred, this chart can be zoomed into the discharge time scale and with extreme precision, the battery voltages can be measured over the entire discharge period. The chart starts every day at zero hours or 12:00 AM.

To zoom into the desired time, simply click the mouse and hold it down while dragging the mouse over the time of interest. As the mouse is dragged across an area, the color will change showing the progress. Then, simply release the mouse button and the chart will automatically update to its new time scale.

### **Discharge Events**

Graphed in whole numbers representing discharges that occurred in a user selected time period. A 3-D Column Chart with adjustable Alpha and Beta Angle for optimum viewing. The graph can be scaled to Days (28-31) by choosing the Year and Month, or Hours (24) by choosing the Date. A popup calendar or numeric selector will appear when choosing fields to adjust this column chart time scale.

### **Discharge Duration**

Graphed in Minutes representing the total discharge time (actual time duration the batteries discharged) for the user selected time period. A 3-D Column Chart with adjustable Alpha and Beta Angle for optimum viewing. The graph can be scaled to Days (28-31) by choosing the Year and Month, or Hours (24) by choosing the Date. A pop-up calendar or numeric selector will appear when choosing fields to adjust this column chart time scale.

### **Discharge Power**

Graphed in VA Output for the user selected time period. Similar to Output VA such that Minimum and Maximum values of Output VA can be selected/un-selected and cause the graph to show both simultaneously or one at a time. The graph can be scaled to Days (30) by choosing the Month, or Hours (24) by choosing the Date. A popup calendar or numeric selector will appear when choosing fields to adjust chart time scale. Since this chart is a 3-D column chart, an adjustment of the Alpha Angle and Beta Angle can be adjusted for optimum viewing.

## **System Logs Page(s)**

The Inverter keeps a record of all critical events such as system tests, events and alarms that occur. The System Logs accessible are Test Logs, Event Logs, Alarm Logs and Discharge Logs.

## **Alarm Logs Page**

Displays all of the Alarms sequentially so that number 1 was the most recent alarm. Displays the Alarm Date, Alarm Time and Alarm Type.

## **Test Logs Page**

Displays all of the System Test results. Similar to Alarm Log, the first log is the most recent System Test. Displays Start Date, Start Time, Duration of Test, Faults Present, Starting and Ending AC Output Voltage, Starting and Ending AC Output Current, Starting and Ending Temperature, Starting and Ending Battery Voltage.

## **Event Logs Page**

Identical to Test Logs except that the cause of the log was a power outage or event. Displays all the same information as the Test Logs.

## **Discharge Logs Page**

Displays the battery voltage after each minute of battery discharge during a test or event. If test or event was shorter than a minute, no data was stored.