

Mini Inverter Typical Wiring Diagrams

Emergency Lighting Central Inverter Systems

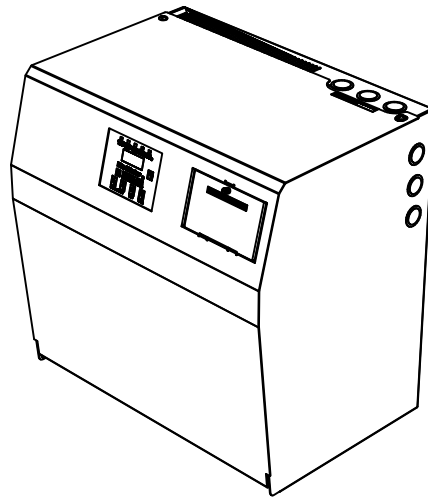

SAVE THESE INSTRUCTIONS

The installation and use of this product must comply with all national, federal, state, municipal or local codes that apply. Please read this manual thoroughly before installing and operating the 300 thru 525 Watt Mini Central Inverter System. For assistance please call technical service at 800-967-5573 and speak to a technician during normal business hours (EST).

Terms:

Switched Command Signal: The Switched Command Signal instructs the Switched Output to turn on or off during normal operation. The Switched Command Signal does not carry current and does not feed the load. When the Switched Command Signal is on, the lighting load (connected to the Switched Output) is fed from the Line through an internal relay- the Switched Command Signal controls this relay.

Note: Do not use dimmers for the Switched Command Signal - see diagrams 3 thru 6 for dimming circuits.

Note: When the Switched Command Signal is not used, the Switched Output becomes an additional Normally Off Output.

Switched Device: This device provides either a signal to the Switched Command Signal or carries current to the lighting load from one of the outputs. Typical devices are Wall Switches, Time Clocks, Photo Cell Controls, Motion Sensors, etc.

Switched Lighting Zones: A zone is a circuit load that is being switched or dimmed for normal lighting use. The maximum number of zones (switched loads) that can be configured is **TWO** only, see diagrams 5 & 6. If more zones are required, an optional EPC series Remote Transfer Device can be purchased per zone.

Normally Off Bypass: Allows the lighting load to be switched or dimmed during normal lighting use. In the event of a power failure (loss of un-switched line) the load is fed from the inverter at full rated line voltage, providing full brightness in the emergency mode.

Normally Off Output: When connected directly to the lighting load (without switch or dimming device) assumes the load to be always off. In the event of a power failure (loss of un-switched line) the load is fed from the inverter at full rated line voltage, providing full brightness in the emergency mode.

Normally On Output: When connected directly to the lighting load (without switch or dimming device) assumes the load to be always on (i.e. Exit Signs, Security Lighting). In the event of a power failure (loss of un-switched line) the load is continued to be fed from the inverter at full rated line voltage.

Typical Wiring Diagram

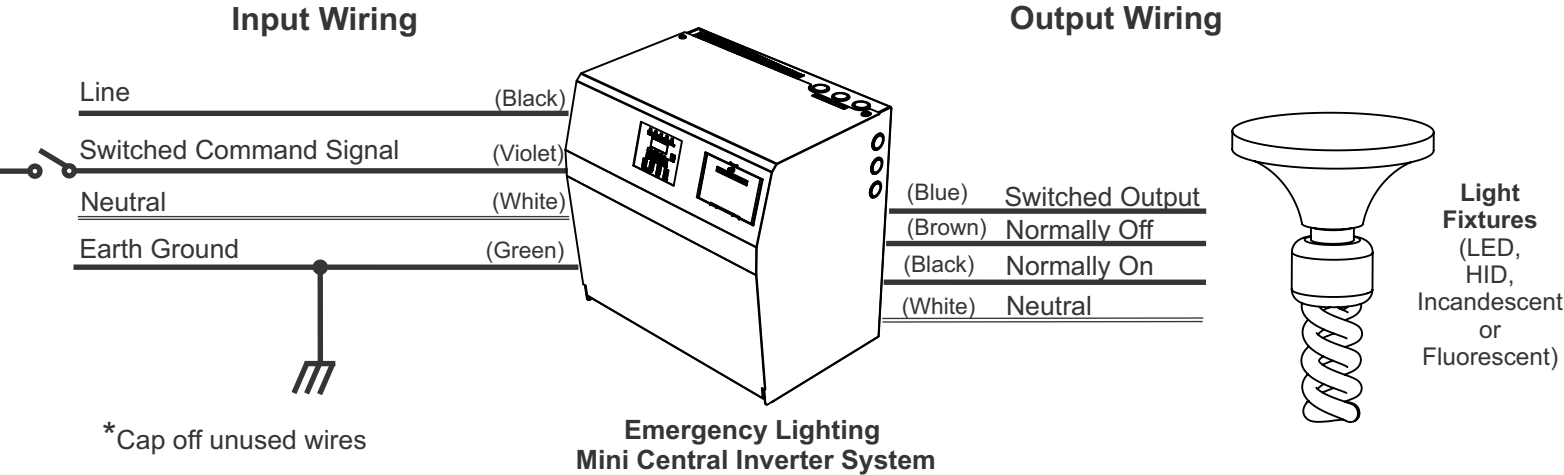

Diagram #1

Standard Switched Lighting Zone

Using The Switched Command Signal

(Not Suitable Dimming Circuits. Use Diagrams 3-6)

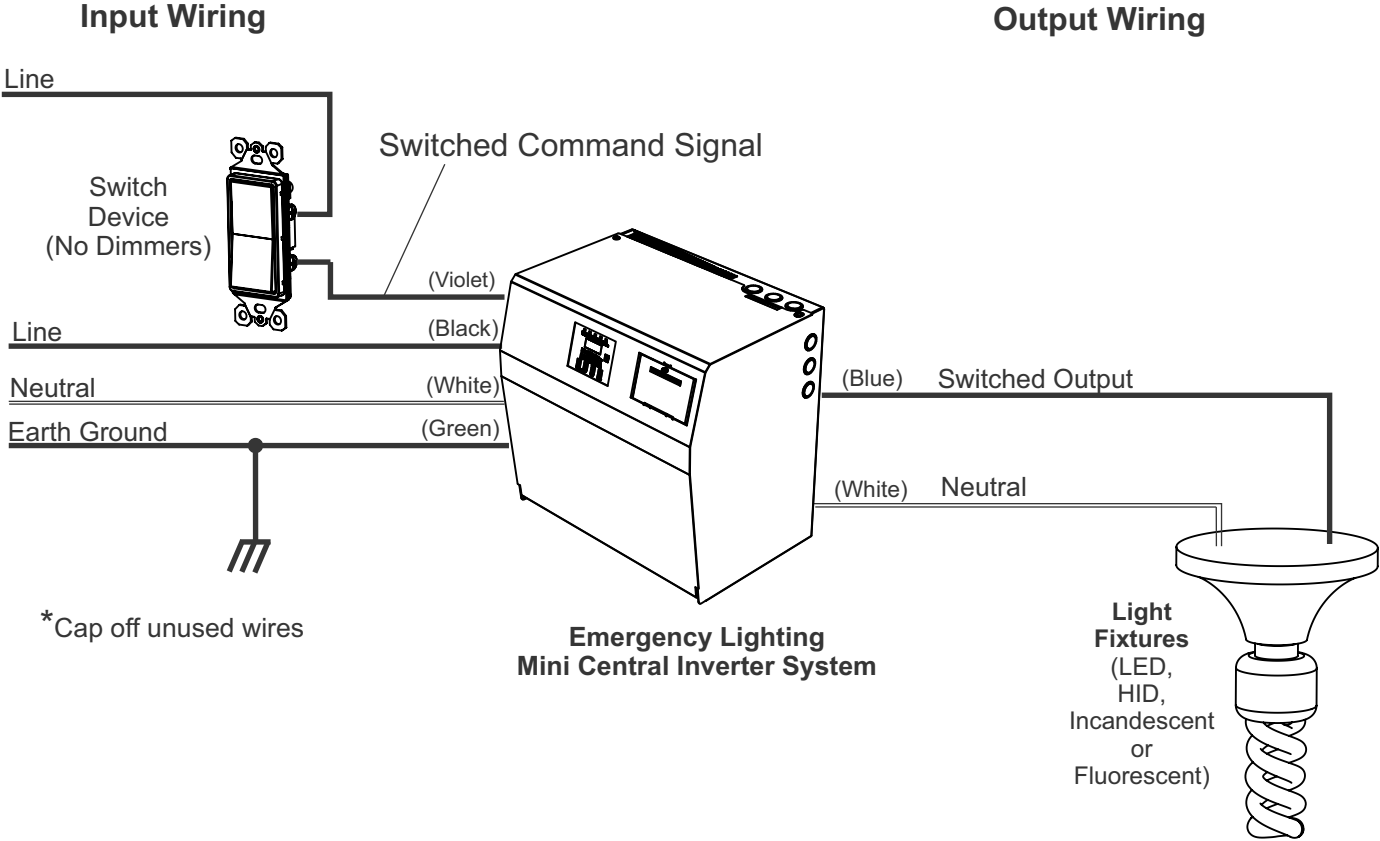

Diagram #2

Dimming or Switched Lighting Zone

Using Normally Off as a Bypass

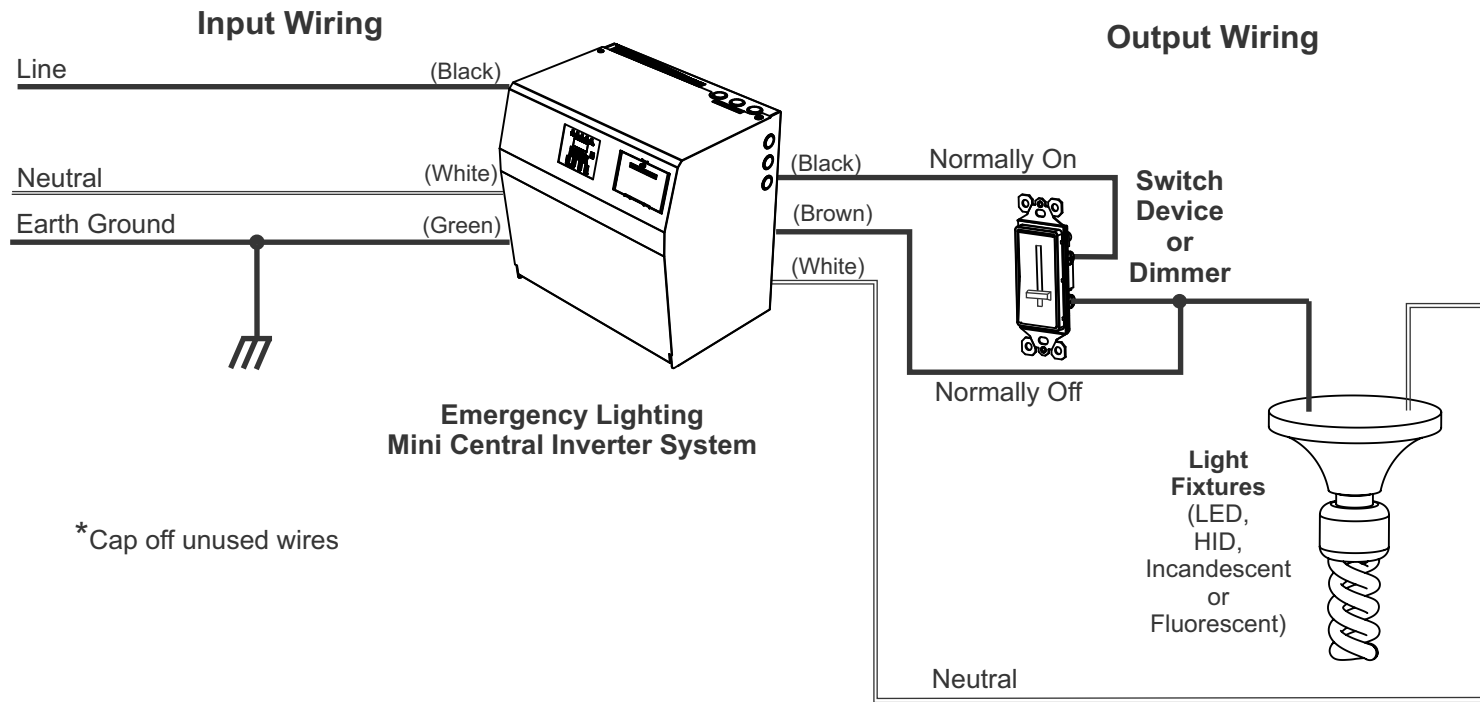

Diagram #3

3 Way Dimming or Switched Lighting Zone

Using Normally Off as a Bypass

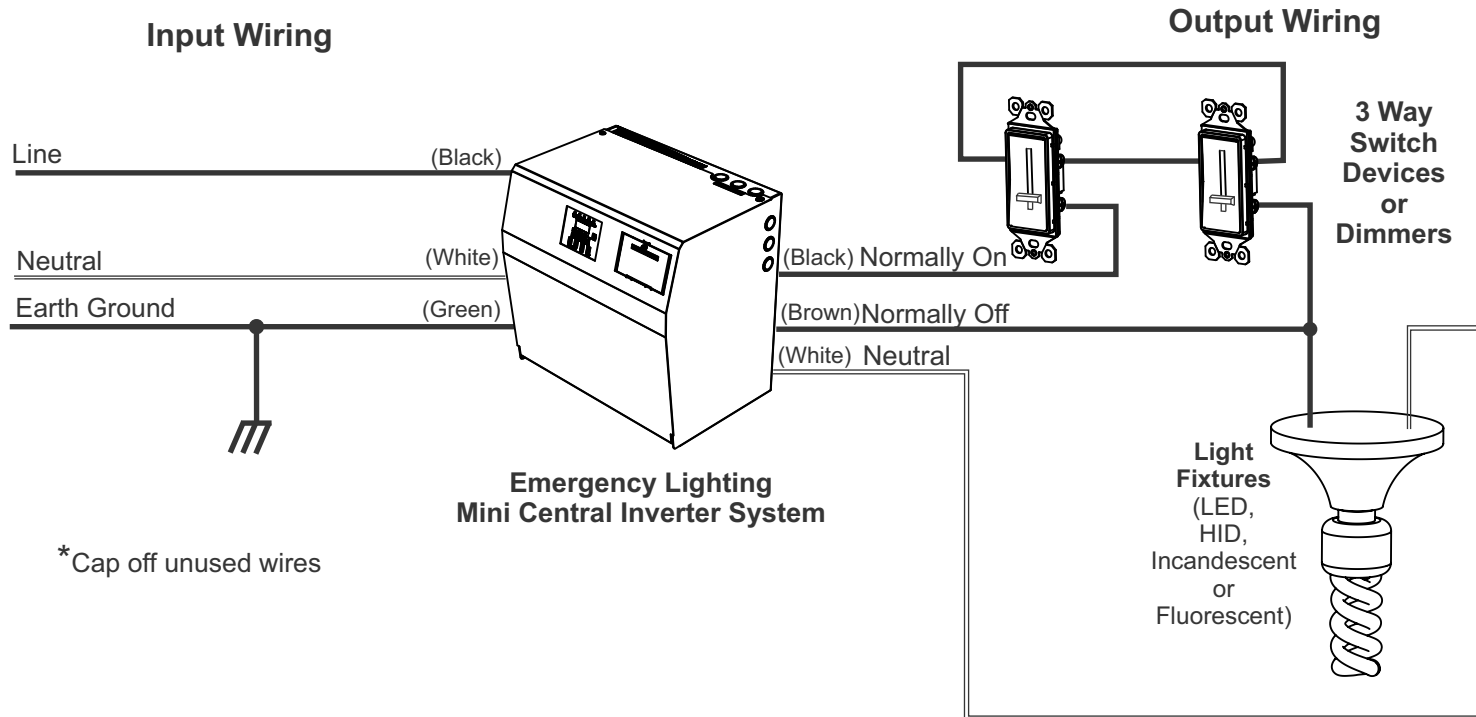

Diagram #4

Two Switched Lighting Zones

Using the Switched Command Signal and Normally Off as a Bypass

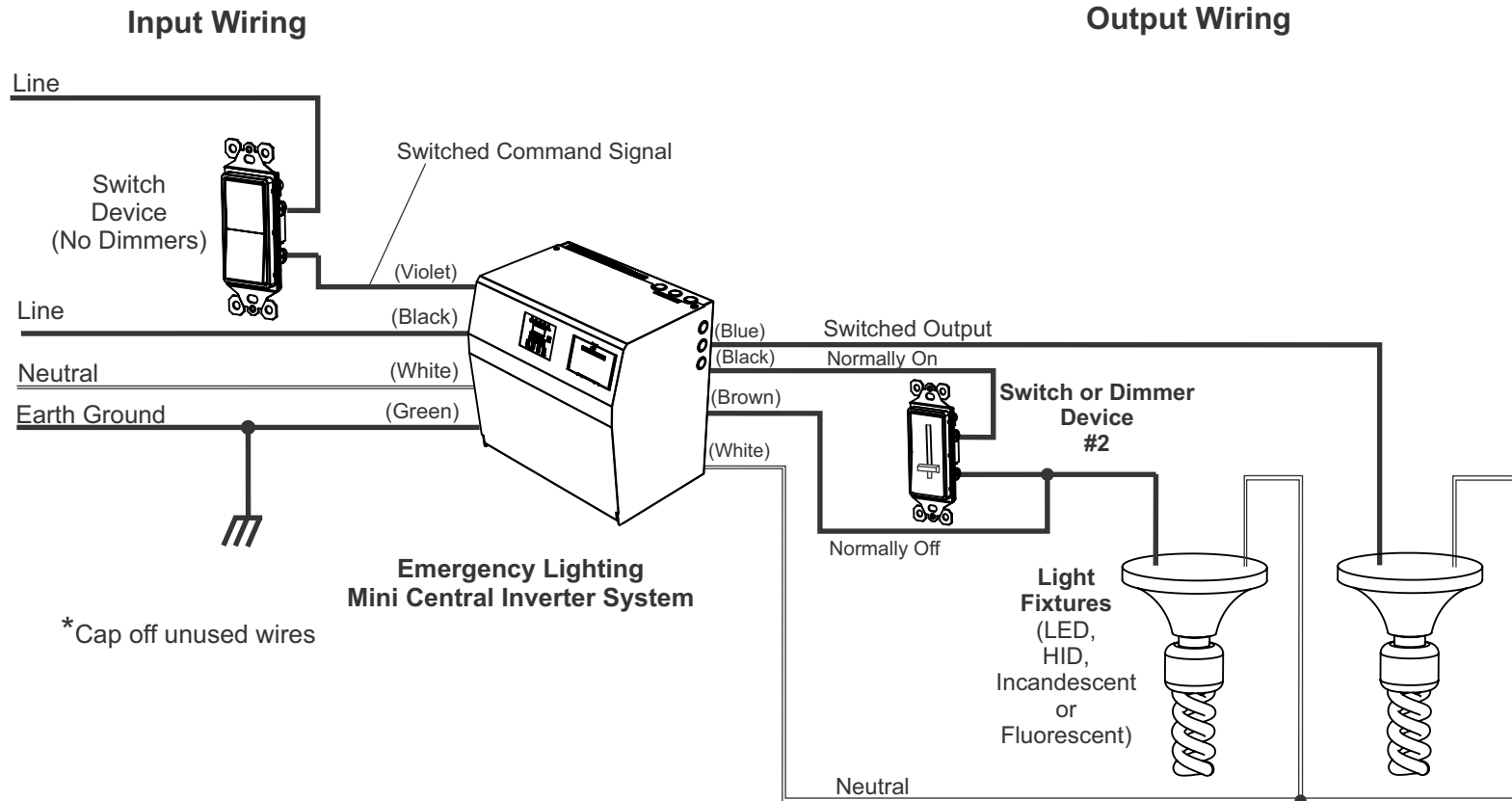

Diagram #5

Two Switched Lighting Zones

Using Normally Off Bypass and Switched Output

Note: When the Switched Command Signal is not used, the Switched Output becomes an additional Normally Off Output

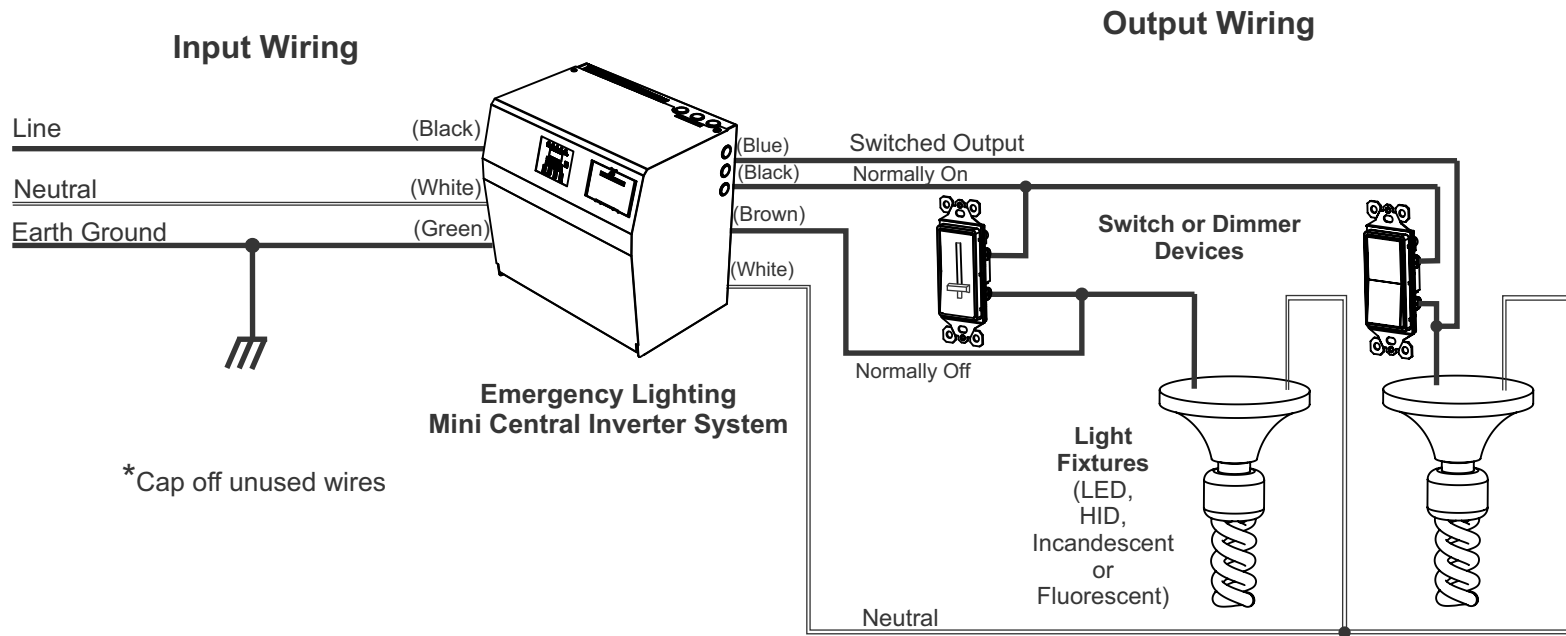

Diagram #6